

DISTRIBUTORI COMPONENTI

SECTIONAL DIRECTIONAL CONTROL VALVES

Distributori componibili Q 30 <i>Sectional directional control valves Q 30</i>	Pag. 4
Distributori componibili Q 50 <i>Sectional directional control valves Q 50</i>	Pag. 6
Distributori componibili Q 80 <i>Sectional directional control valves Q 80</i>	Pag. 8
Distributori componibili Q 130 <i>Sectional directional control valves Q 130</i>	Pag. 10
Cursori <i>Spools</i>	Pag. 12
Colettori di Entrata / Uscita <i>Inlet /Outlet sections</i>	Pag. 15
Comandi <i>Controls</i>	Pag. 17
Posizionamenti <i>Positionings</i>	Pag. 23
Comandi con posizionamento <i>Controls with positioning</i>	Pag. 25
Comandi completi <i>Complete controls</i>	Pag. 30
Elementi intermedi <i>Intermediate sections</i>	Pag. 31
Valvole <i>Valves</i>	Pag. 32

LEGENDA

- **VLP** **Valvola limitatrice di pressione**
Pressure relief valve
- **VR** **Valvola di ritegno**
Check valve
- **A; B** **Effetti**
Ports
- **P** **Linea in pressione**
Pressure line
- **LC** **Libera circolazione**
Through passage
- **T** **Scarico**
Tank return line

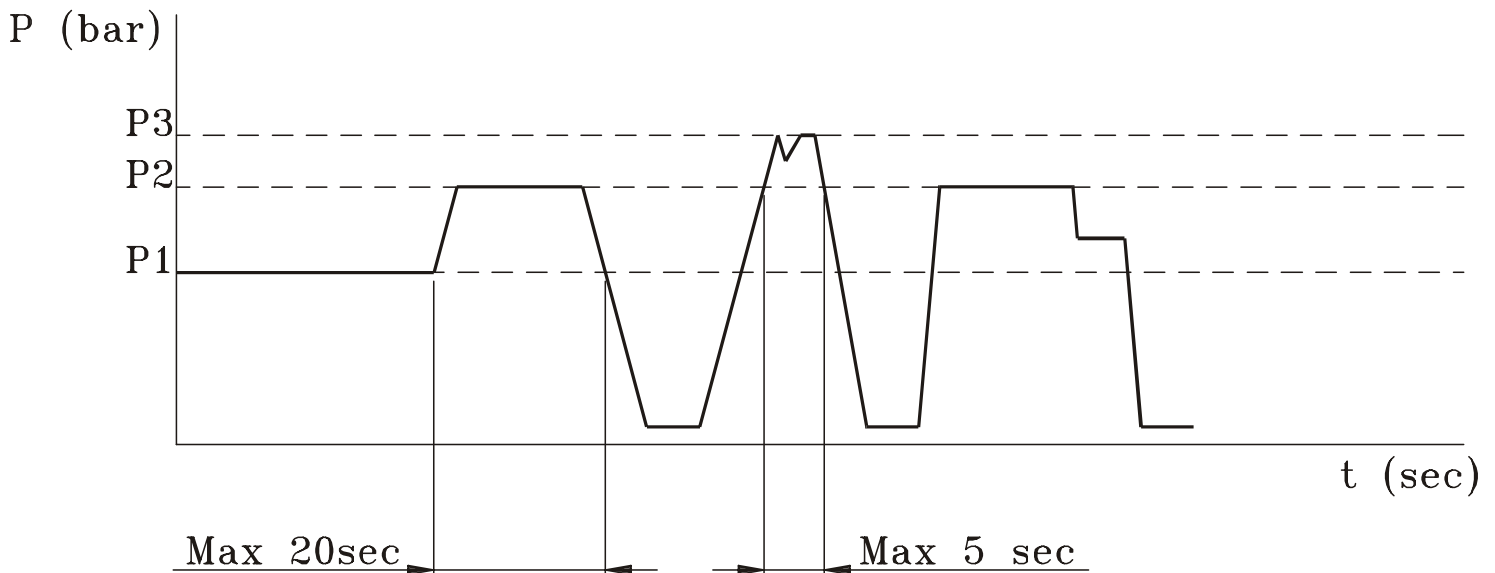

- **P1** **Pressione massima di lavoro (continua)**
Max. continuous pressure
- **P2** **Pressione massima di esercizio (intermittente)**
Max. intermittent pressure
- **P3** **Pressione massima di punta (picco)**
Max. peak pressure

I grafici del seguente catalogo si riferiscono a prove effettuate con olio minerale di viscosità 35 mm² /s alla temperatura di 60 °C.

The diagrams of the following catalogue refer to test made with mineral oil viscosity 35 mm² /s at the temperature of 60 °C.

DISTRIBUTORI COMPONIBILI

- **Maggior versatilità rispetto ai distributori monoblocco e prestazioni superiori.**
- **Esecuzione standard con valvole di ritegno su ogni effetto.**
- **Protezione dei singoli effetti con valvole ausiliarie antishock, anticavitazione e combinate.**
- **Possibilità di diversi tipi di circuito: PARALLELO, SERIE, SINGOLO.**
- **Entrate e scarichi laterali ed intermedi.**
- **Possibilità di inserimento di elementi intermedi con vari tipi di valvole nel medesimo distributore**

SECTIONAL CONTROL VALVES

- *Higher versatility compared to monoblock control valves and higher performances.*
- *Standard execution with check valves on each element.*
- *Protection on single elements with auxiliary antishock, anticavitation and combined valves.*
- *Possibility of different types of circuit: PARALLEL, SERIES and SINGLE.*
- *Side and intermediate inlets and outlets.*
- *Possibility to connect intermediate elements with different type of valves in the same control valves*



AVVERTENZA PER L'INSTALLAZIONE DEI DISTRIBUTORI



- **I quattro e/o tre piedini dei distributori devono sempre appoggiare su una superficie perfettamente piana**
- **Non manomettere i dadi dei tiranti (distributori componibili) in quanto comprometterebbero il normale funzionamento del distributore.**
- **Non utilizzare raccordi conici su filetti cilindrici.**
- **Per pulire il distributore, prima della verniciatura, non utilizzare diluenti/solventi o qualsiasi prodotto che possa intaccare le parti in gomma.**

NOTES FOR DIRECTIONAL CONTROL VALVES ASSEMBLY

- *The four feet e/o three feet of the valve must always and perfectly rest on a plane surface.*
- *Do not tamper the tie rod nuts (sectional directional control valves) so they might impair the standard working of the valve.*
- *No conical nipples with cylindrical thread must be used.*
- *For cleaning a directional control valve, do not use of diluent or any product able to etch rubber parts before the painting.*

Numero massimo di elementi / <i>Max working sections</i>	10			
Limite temperatura olio / <i>Oil range temperature</i>	-30 ÷ 80 °C			
Temperatura olio consigliata / <i>Recommended oil temperature</i>	30 ÷ 60 °C			
Filtraggio consigliato / <i>commended filtering</i>	26/23 ISO DIS 4406			
Fluido / <i>Hidraulic fluid</i>	Olio minerale / <i>Mineral oil</i>			
Viscosità / <i>Viscosity</i>	10 ÷ 400 mm ² /s			
Massa / Mass Kg	Q30	Q50	Q80	Q130
Fiancata d' ingresso + elemento + fiancata di scarico <i>Inlet + working + outlet sectin</i>	3.9	3.9	7.1	15
Elemento aggiuntivo <i>Add mass for each section</i>	1.8	1.8	3	4.9
PRESSIONI MASSIME DI LAVORO bar / MAX WORKING PRESSURE bar				
da 1 a 3 elementi <i>from 1 up to 3 working section</i>	375	375	350	375
da 4 a 6 elementi <i>from 4 up to 6 working section</i>	350	350	320	350
da 7 a 10 sezioni di lavoro <i>from 7 up to working section</i>	325	325	300	325
Pressione max. sullo scarico <i>Max. back pressure</i>	25			

DISTRIBUTORI COMPONIBILI DIRECTIONAL CONTROL VALVE

Q 30

Coppia di serraggio 20 Nm
Tightening torque 20 Nm

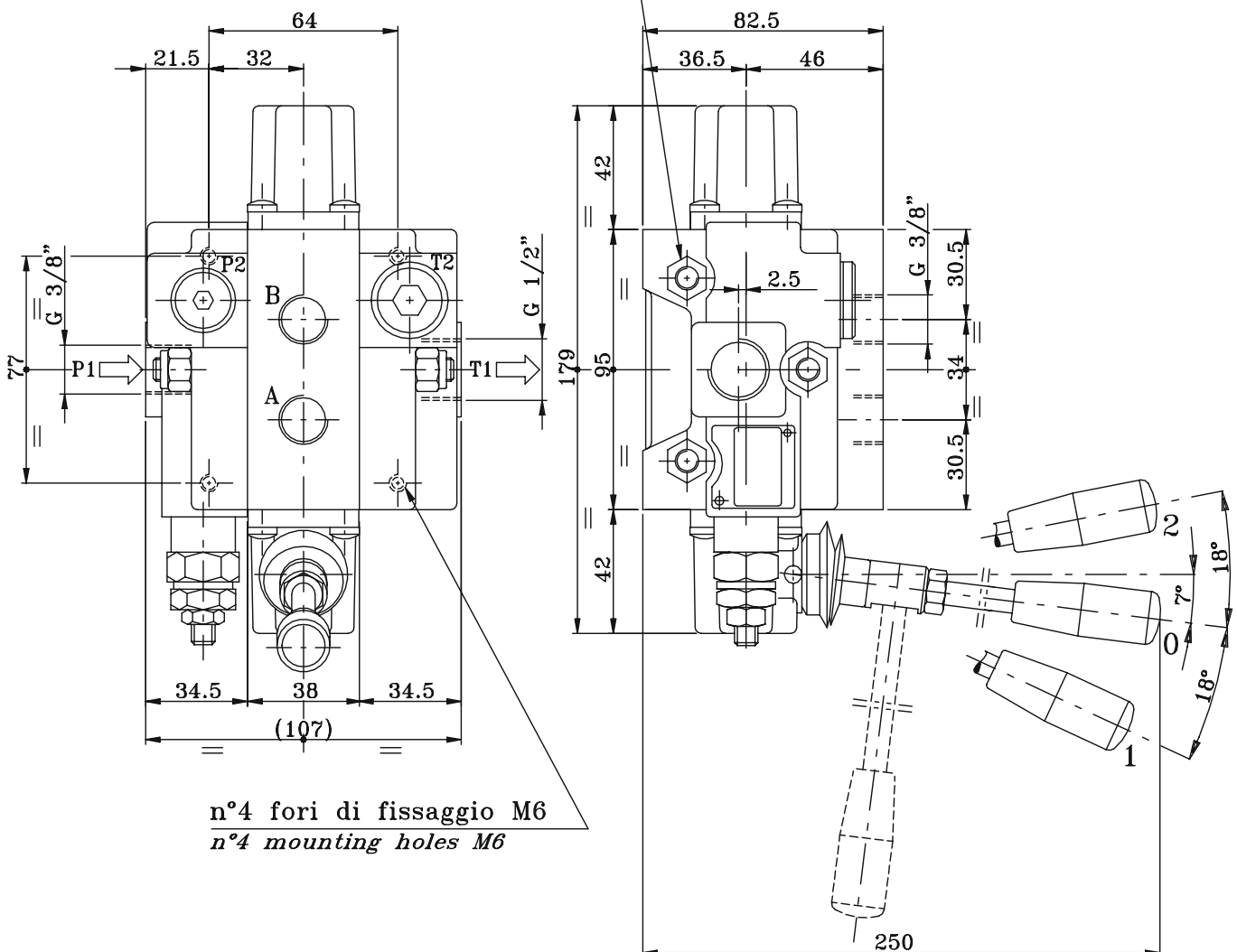

n°4 fori di fissaggio M6
n°4 mounting holes M6

FILETTATURE DISPONIBILI AVAILABLE THREADS

BOCCHIE PORTS	BSP (standard)	SAE
P1	G 3/8"	3/4"-16UNF
P2	G 3/8"	3/4"-16UNF
A-B	G 3/8"	9/16"-18UNF
T1	G 1/2"	7/8"-14UNF
T2	G 1/2"	3/4"-16UNF

TAPPO PER CARRY-OVER (su uscita T1) CARRY-OVER PLUG (on T1 port)

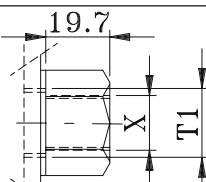
	T1	X	T1	X
	G 1/2"	G 3/8" G 1/2"	7/8"-14UNF	3/4"-16UNF

Q30-PERDITE DI CARICO CON IL CURSORE IN POSIZIONE NEUTRA
Q30-PRESSURE DROP WITH SPOOL IN NEUTRAL POSITION

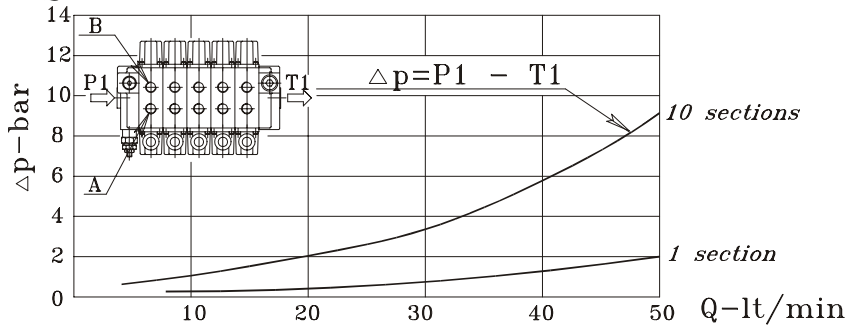

Q30-PERDITE DI CARICO CON IL CURSORE IN POSIZIONE DI LAVORO
Q30-PRESSURE DROP WITH SPOOL IN WORKING POSITION

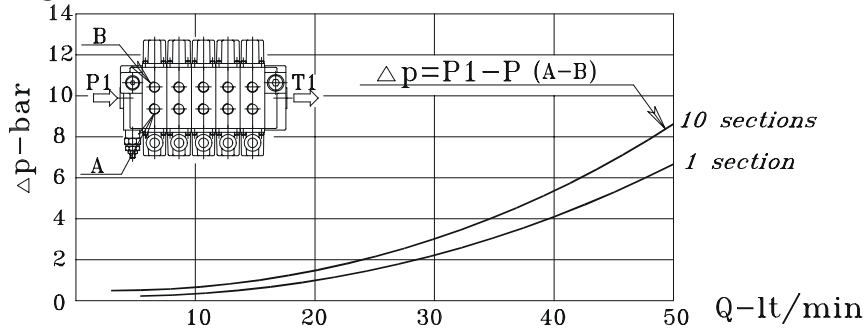

Q30-PERDITE DI CARICO CON IL CURSORE IN POSIZIONE DI LAVORO
Q30-PRESSURE DROP WITH SPOOL IN WORKING POSITION

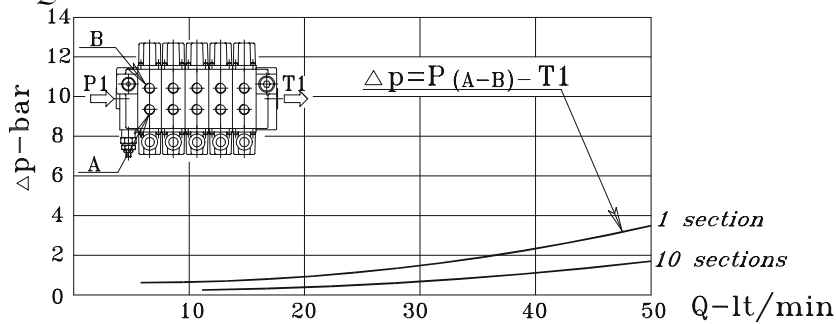

Q30-PERDITE DI CARICO TRA DUE ELEMENTI IN SERIE
Q30-PRESSURE DROP THROUGH TWO SECTIONS CONNECTED IN SERIES

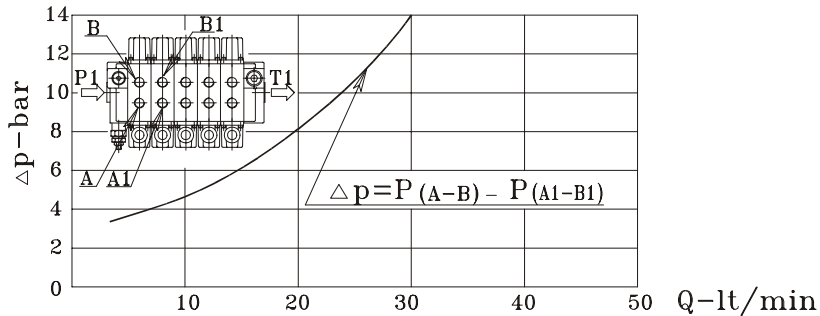

Q30-CURVE DI PROGRESSIVITÀ
Q30-METERING SPOOL

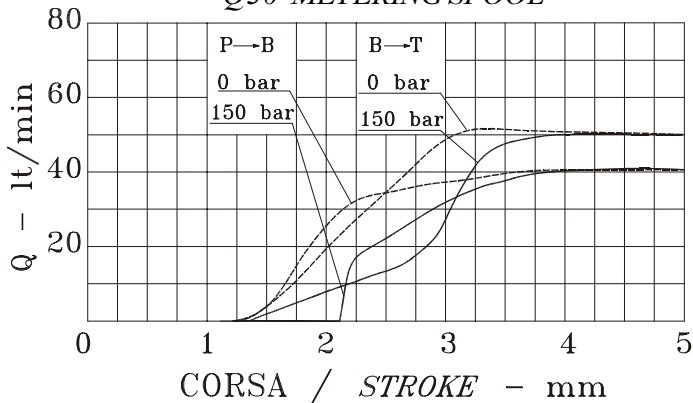

Q30-TRAFILAMENTI SUL CURSORE
Q30-SPOOL LEAKAGE

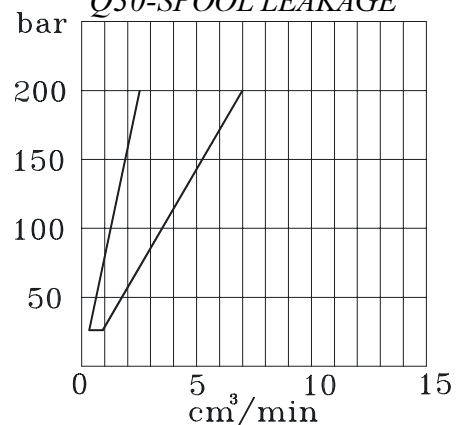

DISTRIBUTORI COMPONIBILI DIRECTIONAL CONTROL VALVE

Q 50

Coppia di serraggio 20 Nm
Tightening torque 20 Nm

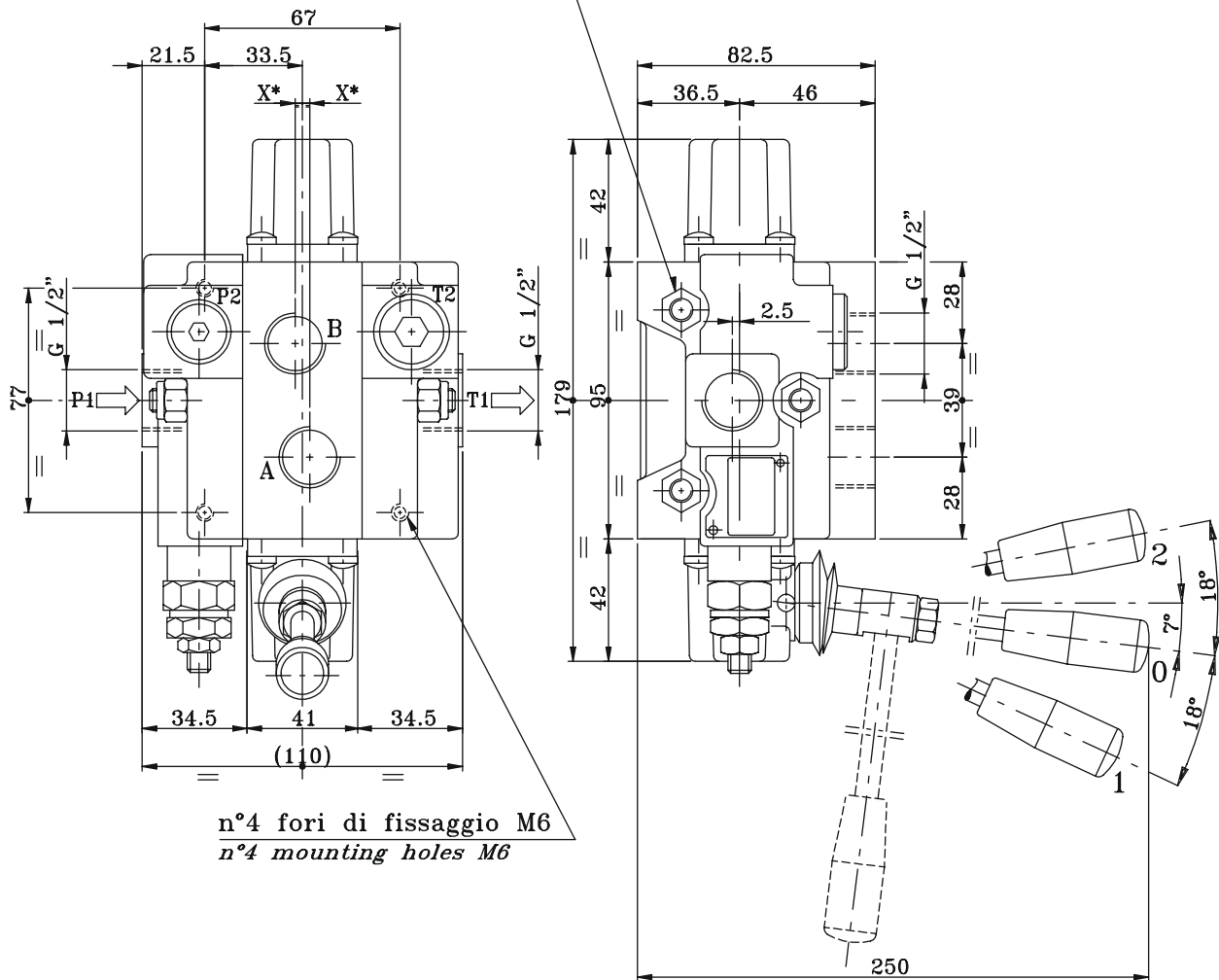

FILETTATURE DISPONIBILI AVAILABLE THREADS

BOCCHIE PORTS	BSP (standard)	SAE
P1	G 1/2"	3/4"-16UNF
P2	G 1/2"	3/4"-16UNF
A-B	G 1/2"	3/4"-16UNF
T1	G 1/2"	7/8"-14UNF
T2	G 1/2"	3/4"-16UNF
Quota X* X* Dimension (mm)	2.5	1.5

TAPPO PER CARRY-OVER (su uscita T1) CARRY-OVER PLUG (on T1 port)

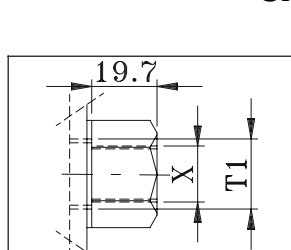
	T1	X	T1	X
	G 1/2"	G 3/8" G 1/2"	7/8"-14UNF	3/4"-16UNF 7/8"-14UNF

Q50-PERDITE DI CARICO CON IL CURSORE IN POSIZIONE NEUTRA

Q50-PRESSURE DROP WITH SPOOL IN NEUTRAL POSITION

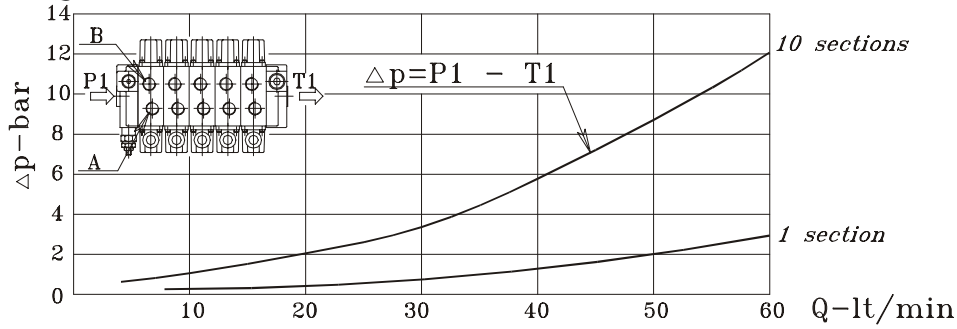

Q50-PERDITE DI CARICO CON IL CURSORE IN POSIZIONE DI LAVORO

Q50-PRESSURE DROP WITH SPOOL IN WORKING POSITION

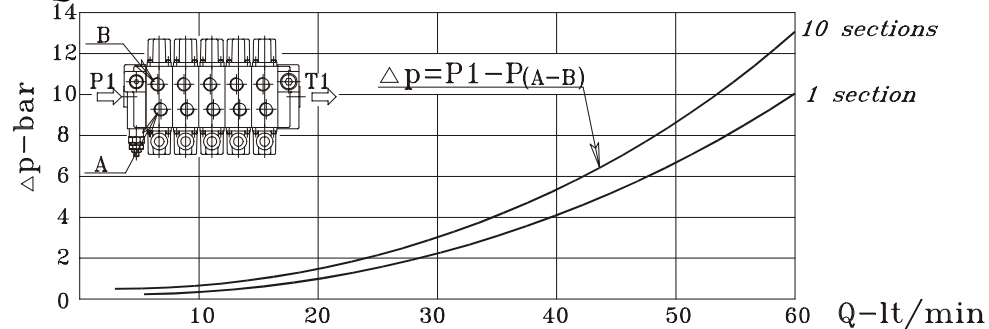

Q50-PERDITE DI CARICO CON IL CURSORE IN POSIZIONE DI LAVORO

Q50-PRESSURE DROP WITH SPOOL IN WORKING POSITION

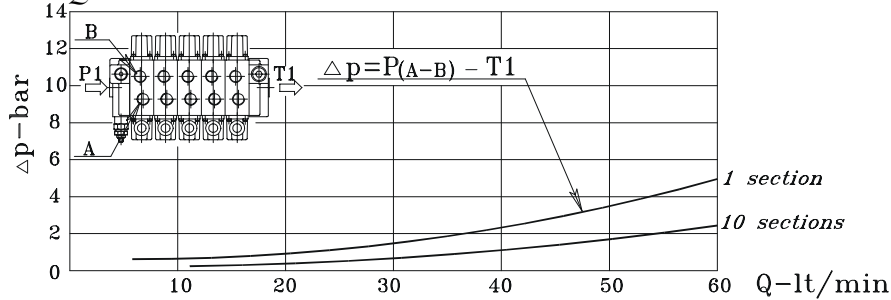

Q50-PERDITE DI CARICO TRA DUE ELEMENTI IN SERIE

Q50-PRESSURE DROP THROUGH TWO SECTIONS CONNECTED IN SERIES

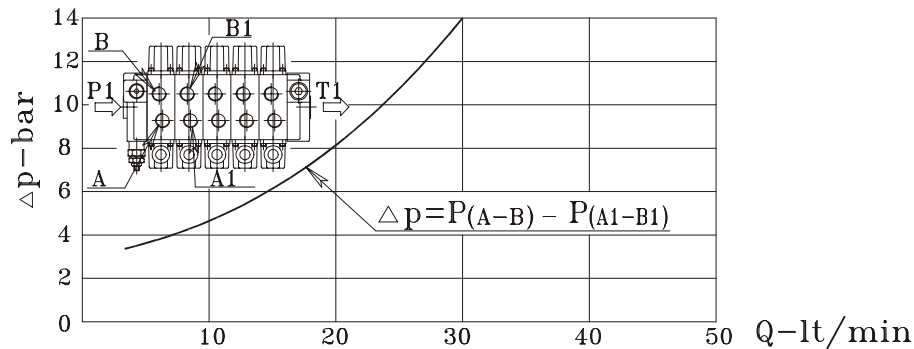

Q50-CURVE DI PROGRESSIVITÀ

Q50-METERING SPOOL

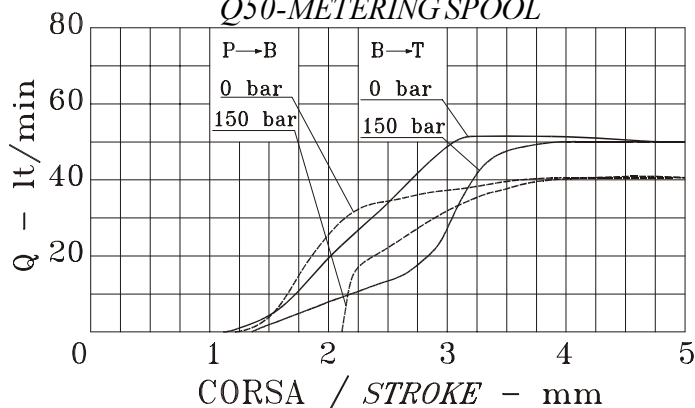

Q50-TRAFILAMENTI SUL CURSORE

Q50-SPOOL LEAKAGE

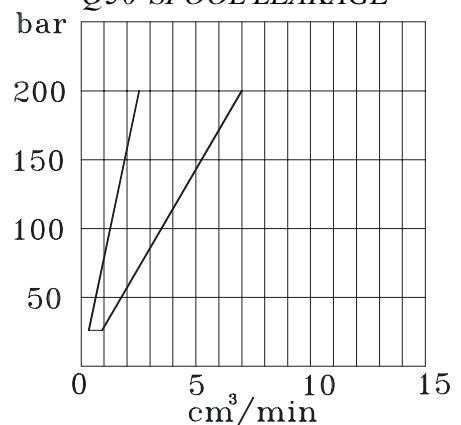

DISTRIBUTORI COMPONIBILI DIRECTIONAL CONTROL VALVE

Q 80

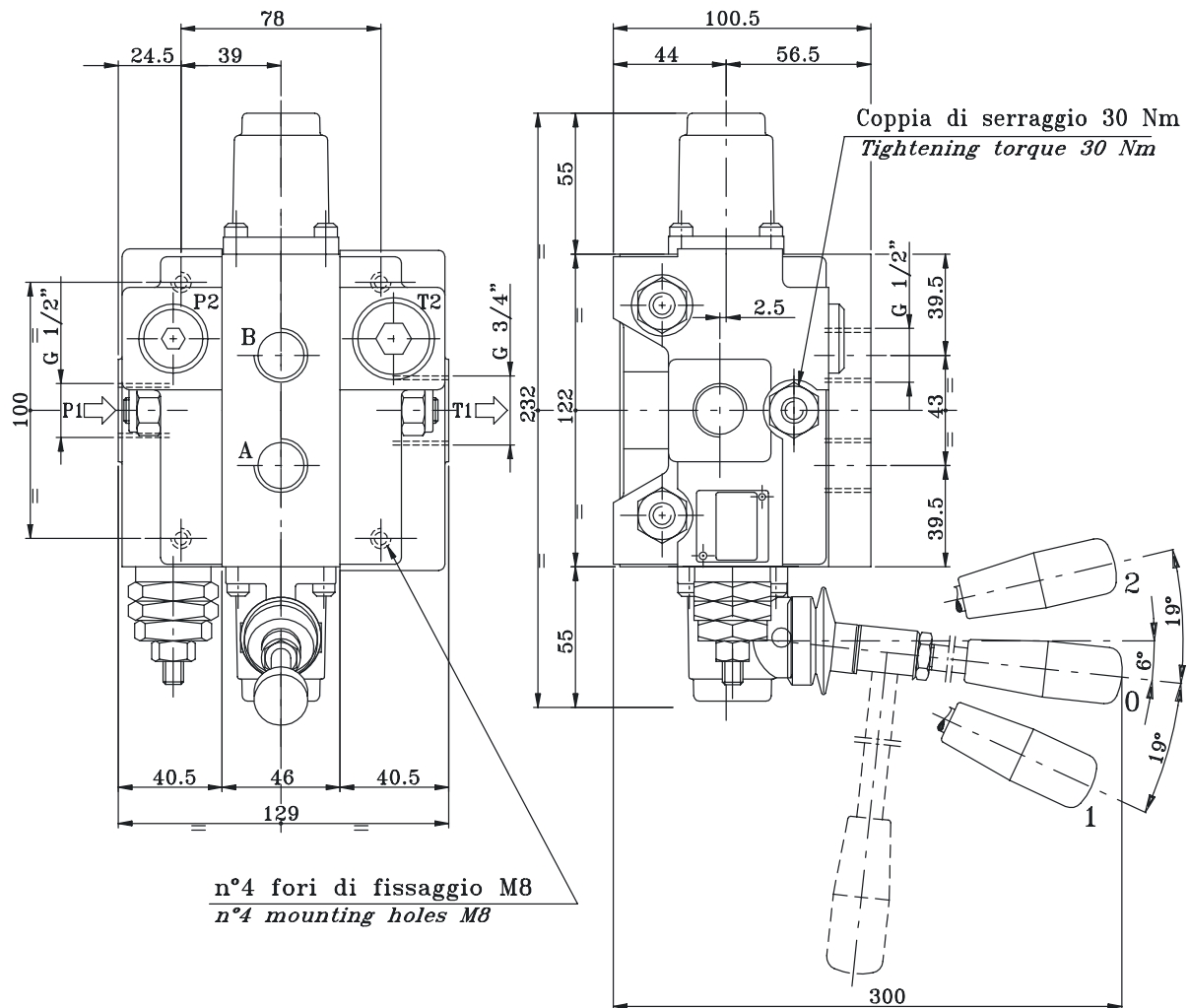

FILETTATURE DISPONIBILI AVAILABLE THREADS

BOCCHIE PORTS	BSP (standard)	SAE	BSP G 3/4"
P1	G 1/2"	7/8"-14UNF	G 3/4"
P2	G 1/2"	7/8"-14UNF	G 3/4"
A-B	G 1/2"	3/4"-16UNF	G 3/4"
T1	G 3/4"	1"1/16-12UN	G 3/4"
T2	G 3/4"	7/8"14-UNF	G 3/4"

TAPPO PER CARRY-OVER (su uscita T1) CARRY-OVER PLUG (on T1 port)

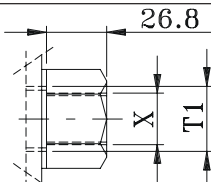
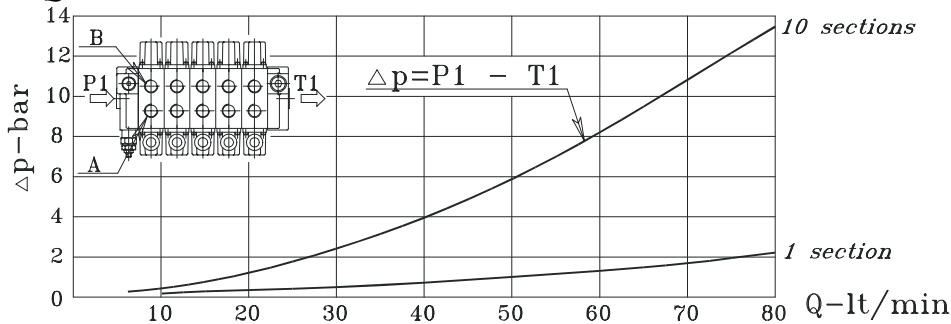

Diagram of the carry-over plug showing dimensions: 26.8 (total length), X (plug length), T1 (port diameter).

T1	X	T1	X	T1	X
G 3/4"	G 1/2" G 3/4"	1"1/16-12UN	7/8"- 14UNF	G 3/4"	G 3/4"

Q80-PERDITE DI CARICO CON IL CURSORE IN POSIZIONE NEUTRA

Q80-PRESSURE DROP WITH SPOOL IN NEUTRAL POSITION



Q80-PERDITE DI CARICO CON IL CURSORE IN POSIZIONE DI LAVORO

Q80-PRESSURE DROP WITH SPOOL IN WORKING POSITION

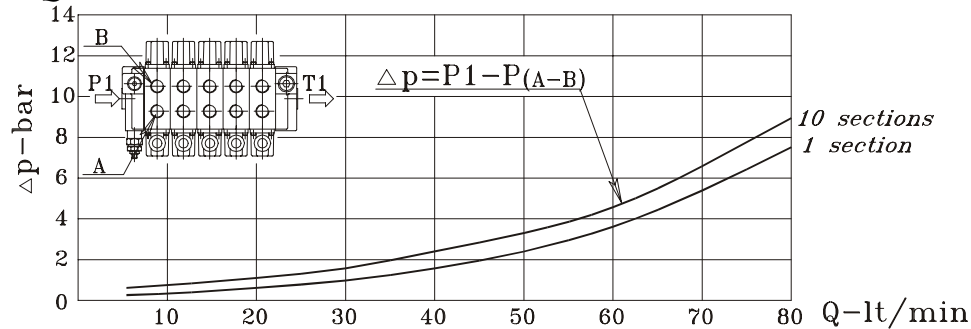

Q80-PERDITE DI CARICO CON IL CASSETTO IN POSIZIONE DI LAVORO

Q80-PRESSURE DROP WITH SPOOL IN WORKING POSITION

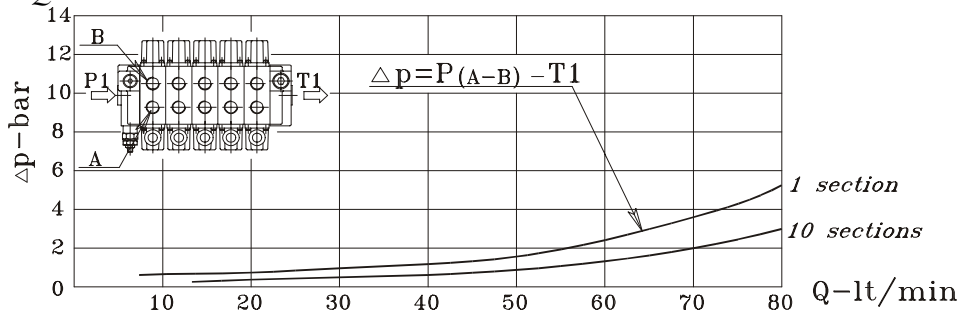

Q80-PERDITE DI CARICO TRA DUE ELEMENTI IN SERIE

Q80-PRESSURE DROP THROUGH TWO SECTIONS CONNECTED IN SERIES

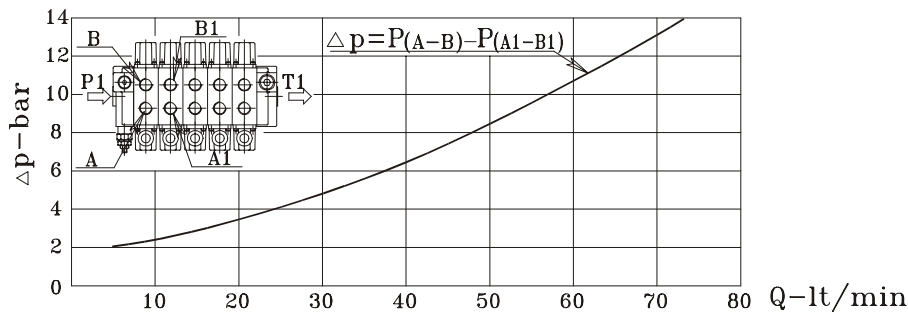

Q80-CURVE DI PROGRESSIVITÀ

Q80-METERING SPOOL

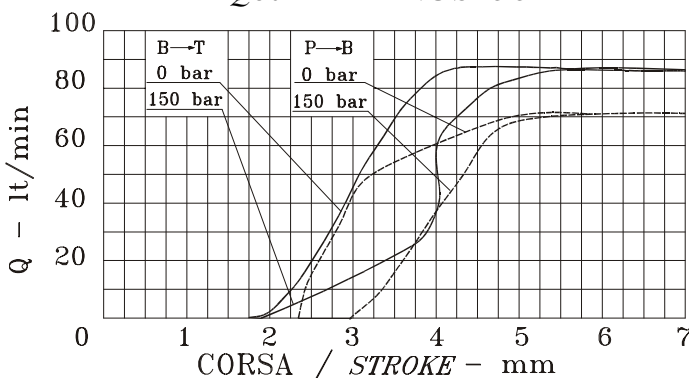

Q80-TRAFILAMENTI SUL CURSORE

Q80-SPOOL LEAKAGE

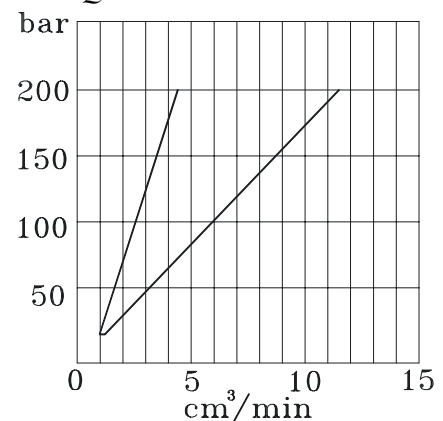

DISTRIBUTORI COMPONIBILI DIRECTIONAL CONTROL VALVE

Q 130

Coppia di serraggio 70 Nm
Tightening torque 70 Nm

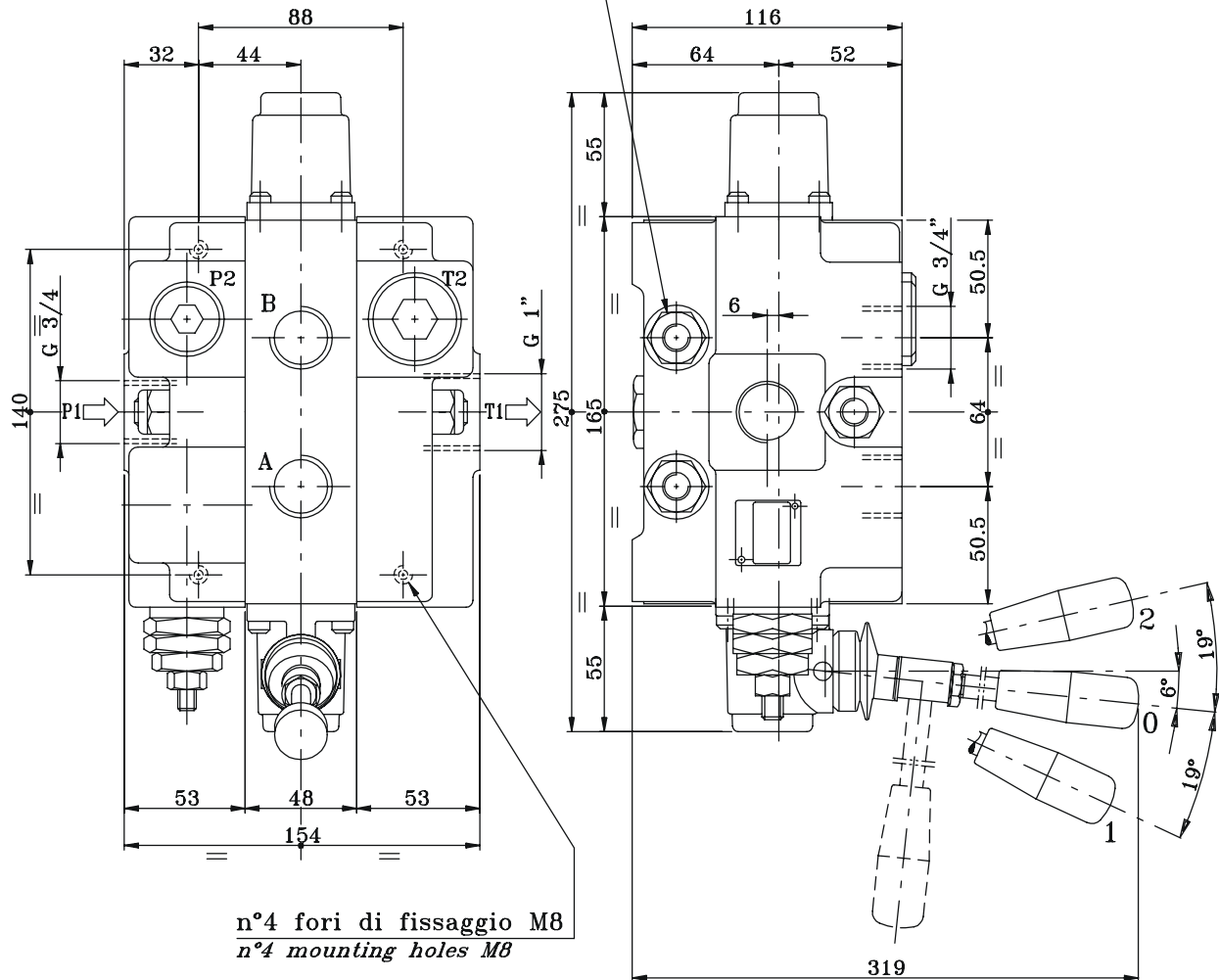

FILETTATURE DISPONIBILI AVAILABLE THREADS

BOCCHIE PORTS	BSP (standard)	BSP G 1"	SAE
P1	G 3/4"	G 1"	1"5/16-12UN
P2	G 3/4"	G 1"	1"5/16-12UN
A-B	G 3/4"	G 1"	1"1/16-12UN
T1	G 1"	G 1"	1"5/16-12UN
T2	G 1"	G 1"	1"5/16-12UN

TAPPO PER CARRY-OVER (su uscita T1) CARRY-OVER PLUG (on T1 port)

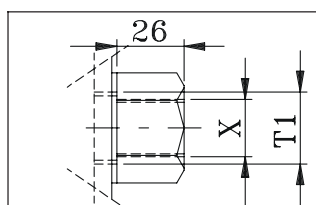
	T1	X	T1	X	T1	X
 <p>Diagram showing the carry-over plug with dimensions: 26 mm total length, X mm thread length, and T1 mm thread diameter.</p>	G 1"	G 3/4" G 1"	G 1"	G 1"	1"5/16-12UN	1"1/16-12UN

Q130-PERDITE DI CARICO CON IL CURSORE IN POSIZIONE NEUTRA

Q130-PRESSURE DROP WITH SPOOL IN NEUTRAL POSITION

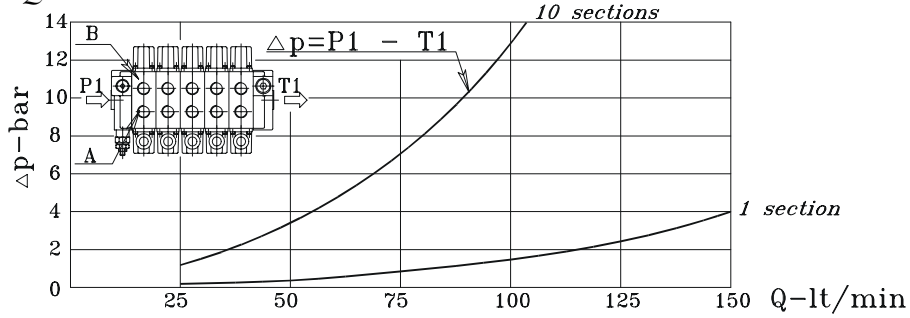

Q130-PERDITE DI CARICO CON IL CURSORE IN POSIZIONE DI LAVORO

Q130-PRESSURE DROP WITH SPOOL IN WORKING POSITION

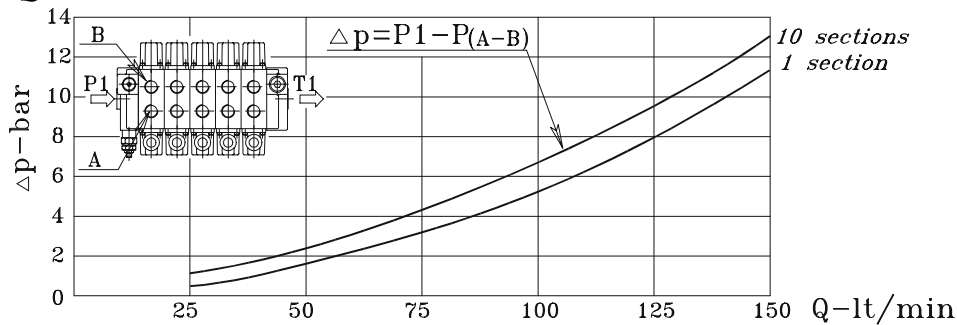

Q130-PERDITE DI CARICO CON IL CURSORE IN POSIZIONE DI LAVORO

Q130-PRESSURE DROP WITH SPOOL IN WORKING POSITION

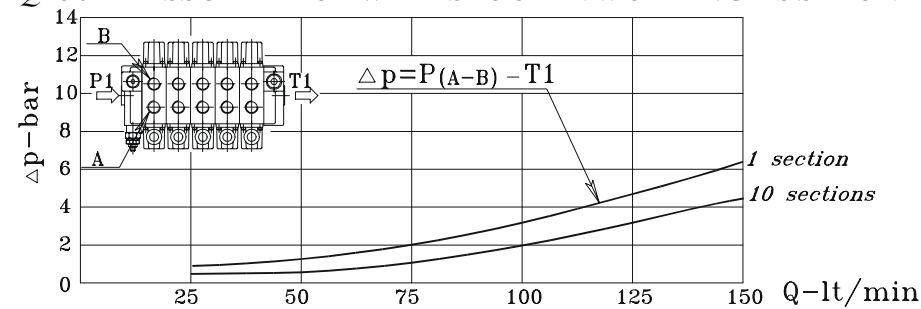

Q130-PERDITE DI CARICO TRA DUE ELEMENTI IN SERIE

Q130-PRESSURE DROP THROUGH TWO SECTIONS CONNECTED IN SERIES

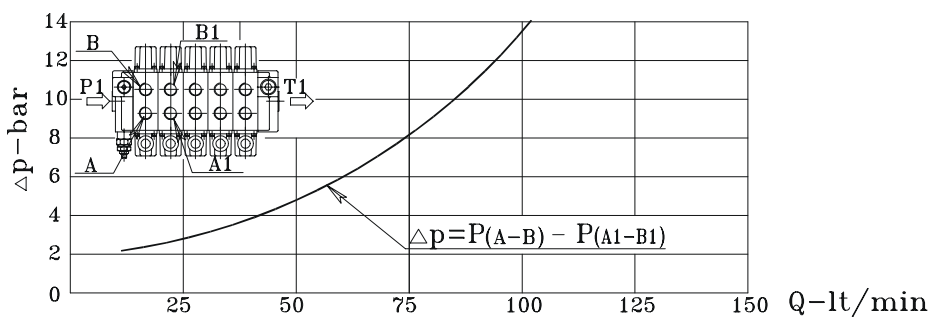

Q130-CURVE DI PROGRESSIVITÀ

Q130-METERING SPOOL

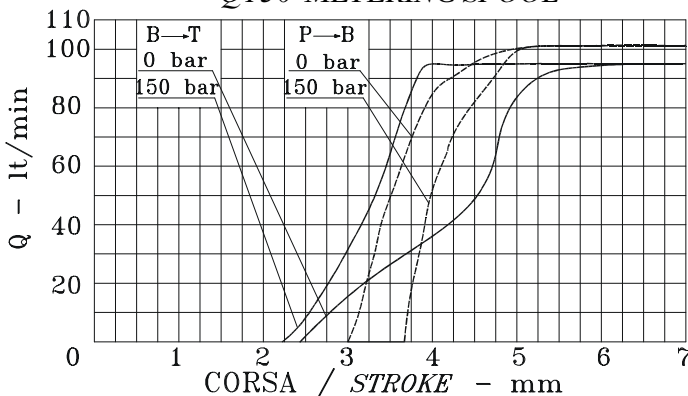

Q130-TRAFILAMENTI SUL CURSORE

Q130-SPOOL LEAKAGE

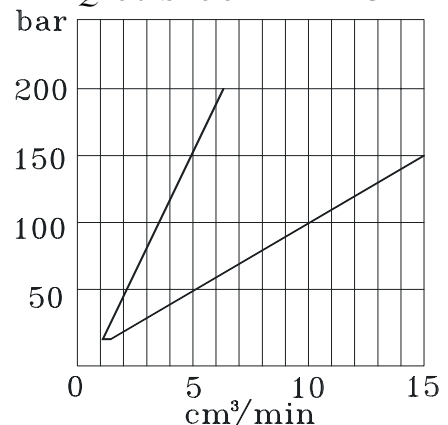

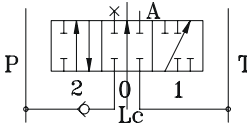
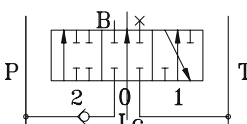
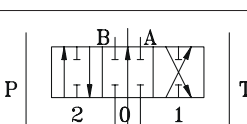
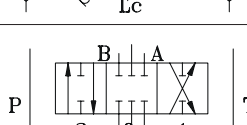
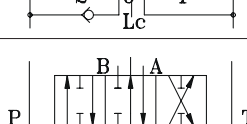
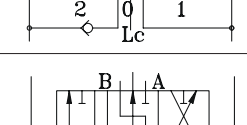
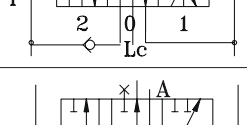
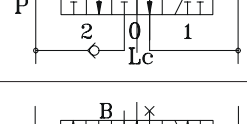
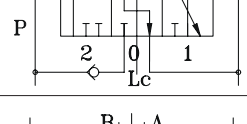
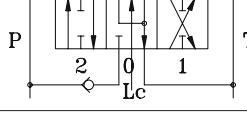
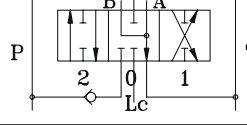
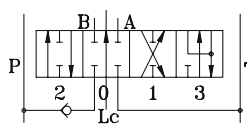
CORSORI PARALLELO / PARALLEL SPOOL			Q30	Q80	Q130
CODICE CODE	SIMBOLO IDRAULICO HYDRAULIC SYMBOL	DESCRIZIONE DESCRIPTION	Q50		
101		Semplice effetto in A. <i>Single acting in A port.</i>	*	*	*
102		Semplice effetto in B. <i>Single acting in B port.</i>	*	*	*
103		Doppio effetto. <i>Double acting.</i>	*	*	*
106		Doppio effetto, passaggi chiusi in posizione 0. <i>Double acting, ports closed in 0 position.</i>	*	*	*
107		Doppio effetto, A in T e B chiuso in posizione 0. <i>Double acting, A to T and B closed in 0 position.</i>	*	*	*
108		Doppio effetto, B in T e A chiuso in posizione 0. <i>Double acting, B to T and A closed in 0 position.</i>	*	*	*
109		Semplice effetto in A, A in T in posizione 0. <i>Single acting in A, A to T in 0 position.</i>	*	*	*
110		Semplice effetto in B, B in T in posizione 0. <i>Single acting in B, B to T in 0 position.</i>	*	*	*
111		Doppio effetto, A e B in T in posizione 0. <i>Double acting, A and B to T in 0 position.</i>	*	*	*
114		Doppio effetto, A e B in T e Lc chiuso in posizione 0. <i>Double acting, A and B to T and through passage closed in 0 position.</i>	*	*	*
116		Doppio effetto con 4^a posizione flottante. <i>Double acting with 4th position floating.</i>	*	*	*
126		Doppio effetto con 4^a posizione flottante. <i>Double acting with 4th position floating.</i>	*	*	

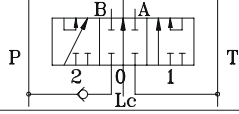
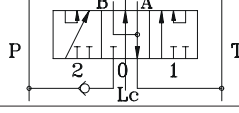
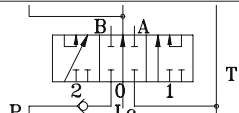
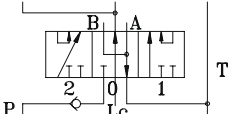
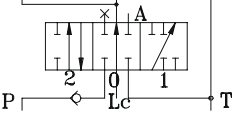
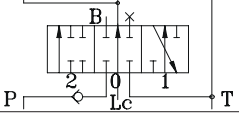
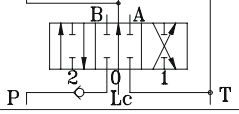
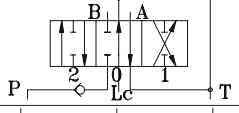
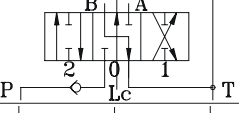
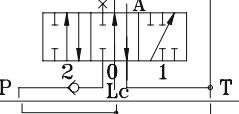
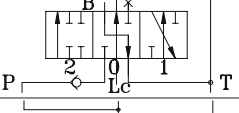
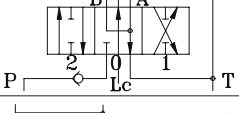
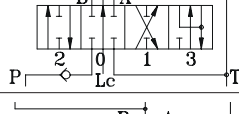
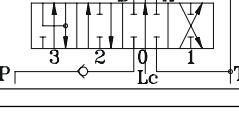
CURSORI SERIE - PARALLELO / SERIE - PARALLEL SPOOLS			Q30	Q80	Q130
CODICE <i>CODE</i>	SIMBOLO IDRAULICO <i>HYDRAULIC SYMBOL</i>	DESCRIZIONE <i>DESCRIPTION</i>	Q50		
303		Doppio effetto SERIE-PARALLELO <i>Double acting SERIE-PARALLEL</i>	*	*	*
311		Doppio effetto SERIE-PARALLELO, A e B in T in pos.0 <i>Double acting SERIE-PARALLEL, A and B to T in 0 position</i>	*	*	*
CURSORI SERIE / SERIE SPOOLS					
403		Doppio effetto SERIE <i>Double acting SERIE</i>	*	*	*
411		Doppio effetto SERIE, A e B in T in pos. 0 <i>Double acting SERIE, A and B to T in 0 position</i>	*	*	*
CURSORI SINGOLI / SINGLE SPOOLS					
201		Semplice effetto in A <i>Single acting in A port</i>	*	*	*
202		Semplice effetto in B <i>Single acting in B port</i>	*	*	*
203		Doppio effetto <i>Double acting</i>	*	*	*
207		Doppio effetto, A in T e B chiuso in posizione 0 <i>Double acting, A to T and B closed in 0 position</i>	*	*	*
208		Doppio effetto, B in T e A chiuso in posizione 0 <i>Double acting, B to T and A closed in 0 position</i>	*	*	*
209		Semplice effetto in A, A in T in posizione 0 <i>Single acting in A, A to T in 0 position</i>	*	*	*
210		Semplice effetto in B, B in T in posizione 0 <i>Single acting in B, B to T in 0 position</i>	*	*	*
211		Doppio effetto, A e B in T in posizione 0 <i>Double acting, A and B to T in 0 position</i>	*	*	*
216		Doppio effetto con 4^ posizione flottante <i>Double acting with 4th position floating</i>	*	*	*
226		Doppio effetto con 4^ posizione flottante <i>Double acting with 4th position floating</i>	*	*	*

CORSORI SENSIBILIZZATI / SENSITIVE SPOOL			Q30 Q50	Q80
CODICE CODE	SIMBOLO IDRAULICO HYDRAULIC SYMBOL	DESCRIZIONE DESCRIPTION		
101.20		Semplice effetto in A. <i>Single acting in A port.</i>	*	
102.20		Semplice effetto in B. <i>Single acting in B port.</i>	*	
103.05		Doppio effetto. <i>Double acting.</i>	*	
103.10		Doppio effetto. <i>Double acting.</i>		*
103.20		Doppio effetto. <i>Double acting.</i>	*	
103.25		Doppio effetto. <i>Double acting.</i>	*	
103.30		Doppio effetto. <i>Double acting.</i>		*
103.40		Doppio effetto. <i>Double acting.</i>	*	
107.20		Doppio effetto, A in T e B chiuso in posizione 0. <i>Double acting, A to T and B closed in 0 position.</i>	*	
108.20		Doppio effetto, B in T e A chiuso in posizione 0. <i>Double acting, B to T and A closed in 0 position.</i>	*	
111.05		Doppio effetto, A e B in T in posizione 0. <i>Double acting, A and B to T in 0 position.</i>	*	
111.10		Doppio effetto, A e B in T in posizione 0. <i>Double acting, A and B to T in 0 position.</i>	*	*
111.20		Doppio effetto, A e B in T in posizione 0. <i>Double acting, A and B to T in 0 position.</i>	*	
111.25		Doppio effetto, A e B in T in posizione 0. <i>Double acting, A and B to T in 0 position.</i>	*	
111.30		Doppio effetto, A e B in T in posizione 0. <i>Double acting, A and B to T in 0 position.</i>		*
111.40		Doppio effetto, A e B in T in posizione 0. <i>Double acting, A and B to T in 0 position.</i>	*	

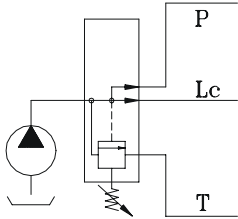
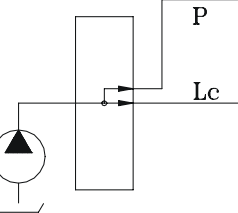
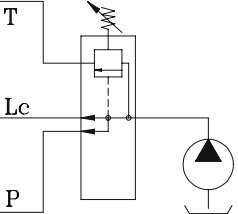
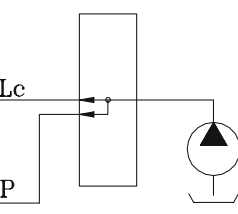
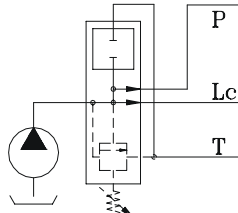
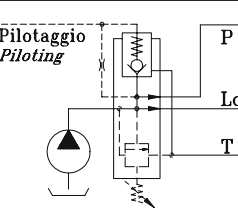
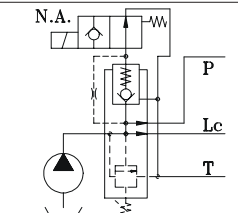
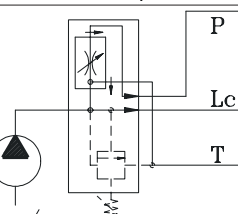
COLLETTORI DI ENTRATA / INLET SECTIONS			Q30 Q50	Q80 Q130
CODICE CODE	SIMBOLO IDRAULICO HYDRAULIC SYMBOL	DESCRIZIONE DESCRIPTION		
F7S		Collettore di entrata sinistro con valvola limitatrice di pressione VLP (* vedi pag. seguente) <i>Left inlet section with relief valve (* see next page)</i>	*	*
F8S		Collettore di entrata sinistro senza valvole <i>Left inlet section without valves</i>	*	*
F7D		Collettore di entrata destro con valvola limitatrice di pressione VLP (* vedi pag. seguente) <i>Right inlet section with relief valve (* see next page)</i>	*	*
F8D		Collettore di entrata destro senza valvole <i>Right inlet section without valves</i>	*	*
F...PMS		Collettore di entrata con predisposizione per valvola di messa a scarico elettrica (indiretta) o idraulica <i>Inlet section presets for electrical outlet release valve (indirect) or hydraulic</i>	*	
F...MSI		Collettore di entrata con valvola di messa a scarico idraulica <i>Inlet section with hydraulic outlet release valve</i>	*	
F...MSE		Collettore di entrata con valvola di messa a scarico elettrica (indiretta) (** vedi pag. seguente) <i>Inlet section with electrical outlet release valve (indirect) (** see next page)</i>	*	
F...VRF		Collettore di entrata con valvola regolatrice di flusso <i>Inlet section flow regulator valve</i>	*	

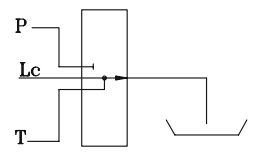
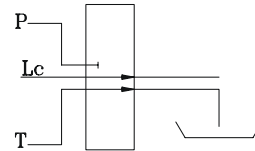
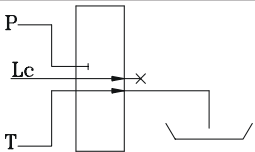
COLLETTORI DI SCARICO/ OUTLET SECTIONS			Q30 Q50	Q80 Q130
CODICE CODE	SIMBOLO IDRAULICO HYDRAULIC SYMBOL	DESCRIZIONE DESCRIPTION		
F3D		Collettore di scarico <i>Outlet section</i>	*	*
F6D		Collettore di scarico con alimentazione in pressione per altri componenti (carry-over) <i>Outlet section and high pressure carry-over</i>	*	*
F16D		Collettore di scarico destro per centro chiuso <i>Right outlet section for through passage closed</i>	*	*

(*) **Taratura o campo di taratura della valvola limitatrice di pressione (VLP) da specificare in bar nell'ordine:**

"B" = molla bianca per tarature da 10 a 100 bar.

"N" = molla nera (standard) per tarature da 40 a 200 bar

"R" = molla rossa per tarature da 180 a 350 bar

N.B.: in caso di omissione del valore di taratura, esso sarà inteso standard a 150 bar

(*) *Calibration fields of the pressure relief valve to specify during the purchase order (in bar):*

"B" = white spring for calibration field ranging between 10 and 100 bar

"N" = black spring (standard) for calibration field ranging between 40 and 200 bar

"R" = red spring for calibration field ranging between 180 and 350 bar

N.B.: If this details is not mentioned in the order, calibration will be set at the standard level of 150 bar.

(**) **Specificare tensione e schema dell'elettrovalvola**

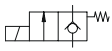
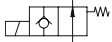

(**) *Specify voltage and scheme of the solenoid operated valve*

12 V.DC
24 V.DC

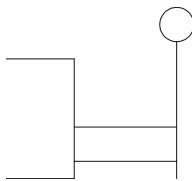
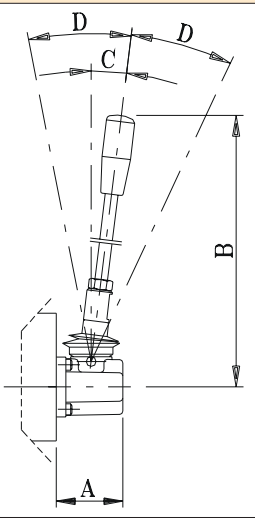
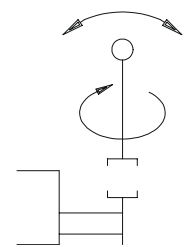
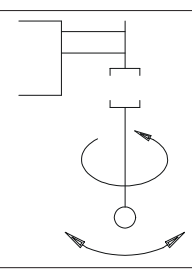
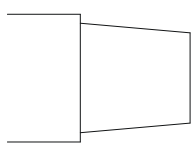
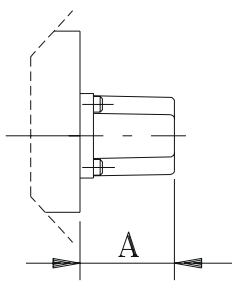
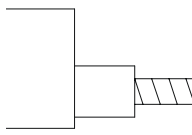
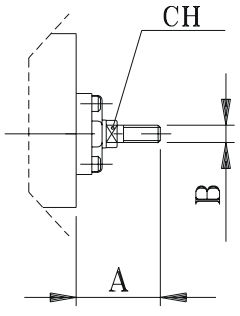
Normalmente chiusa = N.C. 
Normalmente aperta = N.A. 

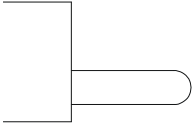
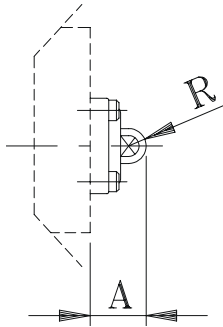
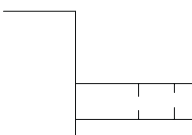
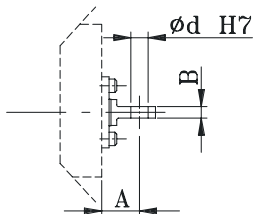
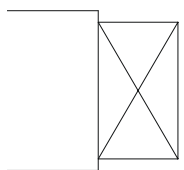
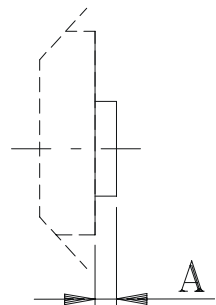
COMANDI / CONTROLS				Q25	Q30	Q75	Q80
CODICE CODE	SIMBOLO IDRAULICO HYDRAULIC SYMBOL	DESCRIZIONE DESCRIPTION		Q45	Q50	Q95	Q130
A1		Comando manuale con leva standard. <i>Hand control with standard lever.</i>		A	42	55	
				B	205	260	
A2	Comando manuale con leva standard ruotata di 180°. <i>Hand control with standard lever mounted rotated 180°.</i>	C		7°	6°		
D		18°		19°			
A12		Comando manuale con leva di sicurezza del tipo "uomo morto" <i>Hand control with safety "dead man" type lever.</i>	A	42	55		
			B	273.5	288		
A13		Comando manuale con leva di sicurezza del tipo "uomo morto" ruotata di 180° <i>Hand control with safety "dead man" type lever mounted rotated 180°.</i>	C	7°	6°		
			D	18°	19°		
A3		Scatola di protezione in sostituzione del comando manuale con leva. <i>Proof cap replacing hand control with lever.</i>		A	42	55	
A4		Attacco diretto sul cursore per rinvio a distanza rigido. <i>Direct control connection on spool for stiff remote control.</i>		A	39	53	
				B	M8	M10	
				CH	9	14	
				CORSA ± STROKE	5	7	

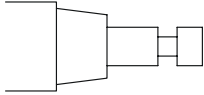
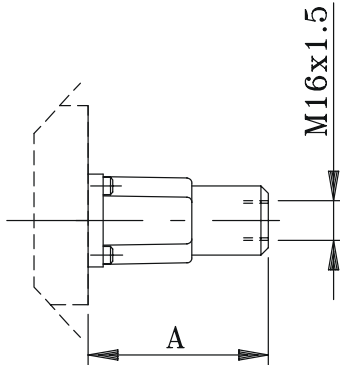
COMANDI / CONTROLS				Q25 Q45	Q30 Q50	Q75 Q95	Q80 Q130
CODICE CODE	SIMBOLO IDRAULICO HYDRAULIC SYMBOL		DESCRIZIONE DESCRIPTION				
A5		Attacco diretto sul cursore con terminale sferico. (da utilizzare solo con il posizionamento M4 (2-1)) <i>Direct control connection on spool with spherical end. (Control to be used for positioning M4 (2-1)).</i>		A	22	33	
				R	6.85	8.75	
				CORSA ± STROKE	5	7	
A6		Attacco diretto sul cursore con terminale ad occhio fisso. <i>Direct control connection on spool eye end.</i>		A	20	27	
				B	6	7	
				d	9	11	
				CORSA ± STROKE	5	7	
Z1		Kit ausiliario da montare sul lato comando per cursori con 4^ posizione e posizionatore R8. <i>Auxiliary kit to be mounted on control side for spool with 4th position and positioning R8.</i>		A	8.5	13.5	

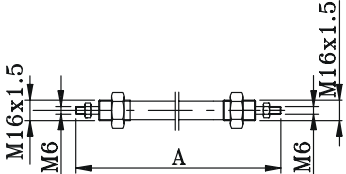
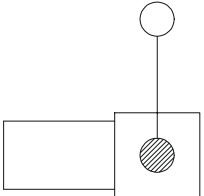
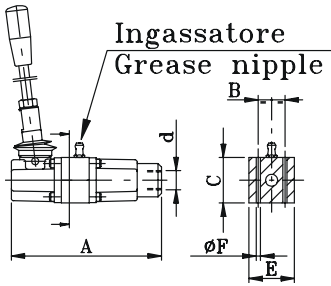
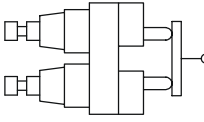
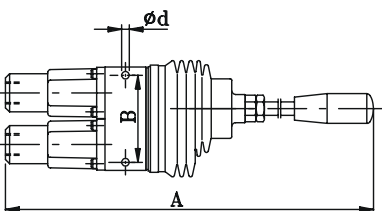

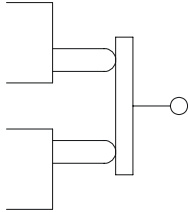
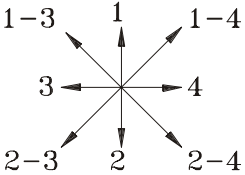
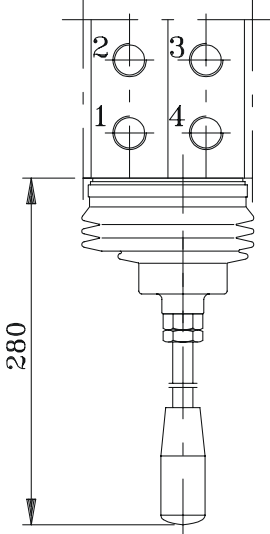
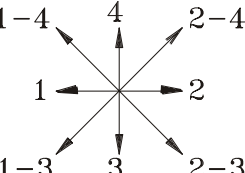
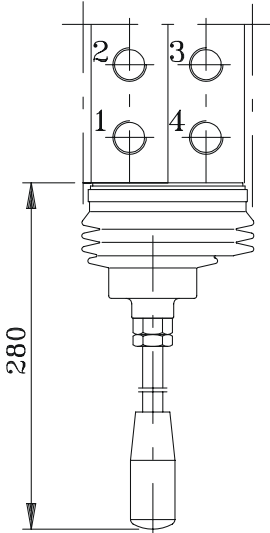
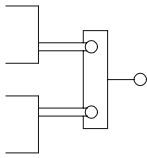
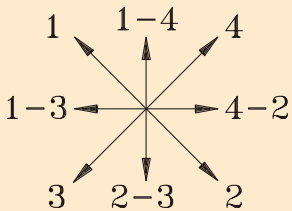
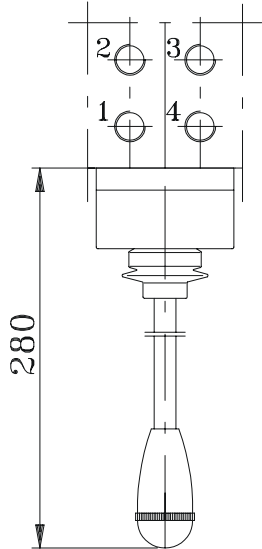

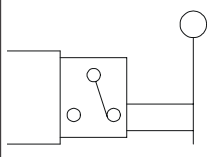
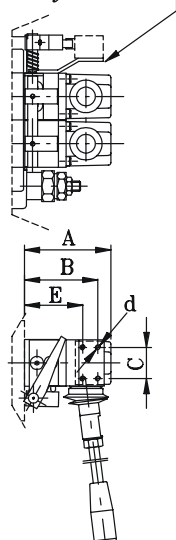
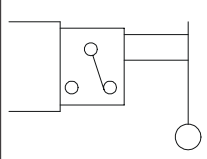
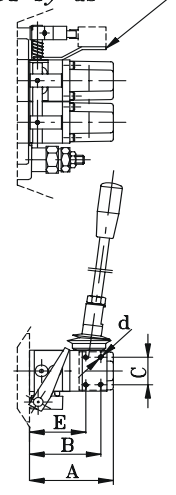
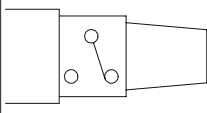
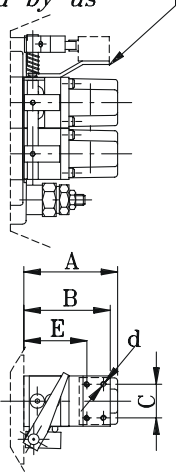

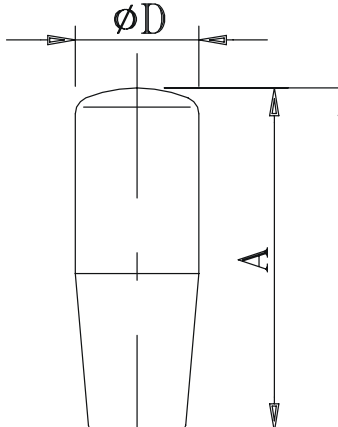
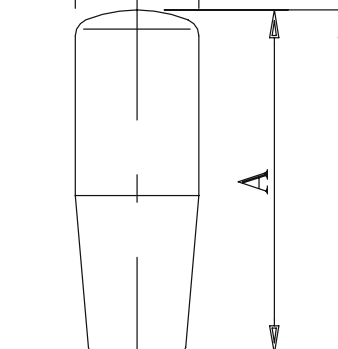
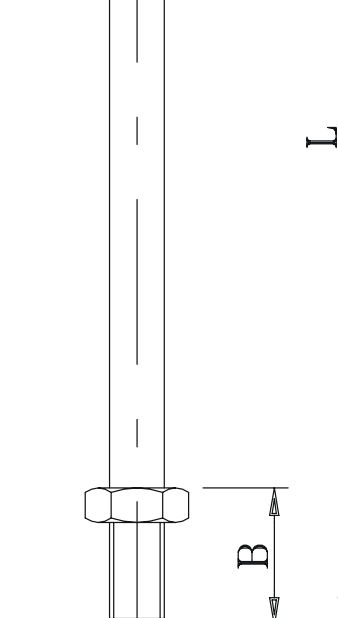
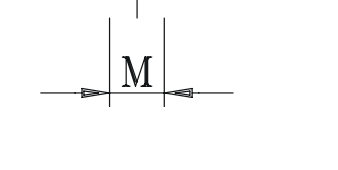
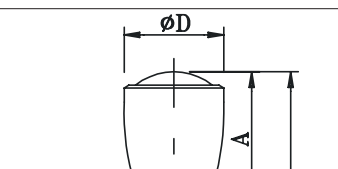
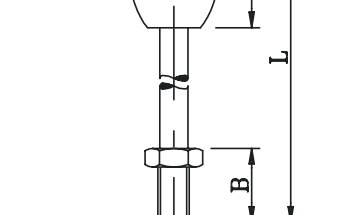
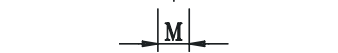

COMANDI / CONTROLS				Q25	Q30	Q75	Q80
CODICE CODE	SIMBOLO IDRAULICO HYDRAULIC SYMBOL	DESCRIZIONE DESCRIPTION		Q45	Q50	Q95	Q130
A8		Attacco diretto sul cursore per cavo flessibile rinvio a distanza. <i>Direct connection on spool for remote flexible control.</i>		A	73	77	
C1		Cavo flessibile. <i>Flexible cable.</i>		A	Massima lunghezza cavo consigliata 4000 mm Raggio min. di curvatura: 200 mm <i>Max. recommended length 4000 mm</i> <i>Minimum radius curve 200 mm</i>		
SL		Comando a distanza. <i>Remote control.</i>		A	135	172	
				B	26	33.5	
				C	40	45	
				d	M16x1.5		
				E	38	45	
				F	5.5	6.5	
SLA15		Comando a cloche per controllo simultaneo di due cursori a distanza. <i>Remote cloche lever control for simultaneous operation of two spools.</i>		A	358		
				B	77		
				Ø d	6.5		
				Q25 Q45	Q30 Q50	Q75 Q95	Q80 Q130

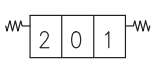
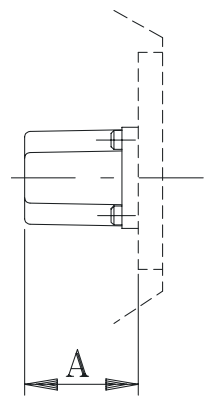
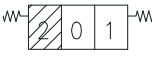
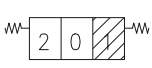
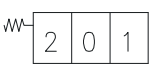
COMANDI / CONTROLS			Q25 Q45	Q30	Q50	Q75 Q95	Q80 Q130	
CODICE CODE	SIMBOLO IDRAULICO HYDRAULIC SYMBOL	DESCRIZIONE DESCRIPTION						
A15		<p>A15S Con fulcro a sinistra. <i>With fulcrum on the left.</i></p> <p>Leva a cloche per il comando singolo o simultaneo di due cursori, come a schema sottoindicato.</p> <p><i>Cloche lever for simultaneous or single control of two spools, as from the scheme here below.</i></p> 		*	*	*	*	*
		<p>A15D Con fulcro a destra. <i>With fulcrum on the right.</i></p> <p>Leva a cloche per il comando singolo o simultaneo di due cursori, come a schema sottoindicato.</p> <p><i>Cloche lever for simultaneous or single control of two spools, as from the scheme here below.</i></p> 		*	*	*	*	*
A16		<p>Leva a cloche per il controllo singolo o simultaneo di due cursori come a schema sottoindicato.</p> <p><i>Cloche lever for single or simultaneous control of two spools as from the scheme here below.</i></p> 		*	*			

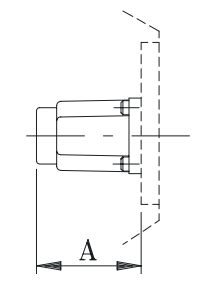
COMANDI / CONTROLS				Q25	Q30	Q75	Q80
CODICE CODE	SIMBOLO IDRAULICO HYDRAULIC SYMBOL	DESCRIZIONE DESCRIPTION		Q45	Q50	Q5	Q130
N1-A1 N1A-A1 N1B-A1		<p>Comando manuale con attivazione del contatto elettrico del microswitch centralizzato.</p> <p>N1-A1: Per doppio effetto N1A-A1: Per semplice effetto in pos 1 N1B-A1: Per semplice effetto in pos 2</p> <p><i>Hand control with ON-OFF centralized microswitch operation.</i></p> <p><i>N1-A1: Double acting</i> <i>N1A-A1: Single acting in 1 position</i> <i>N1B-A1: Single acting in 2 position</i></p>	<p>Microswitch non di nostra fornitura <i>Microswitch not supplied by us</i></p> 	A	70	84	
				B	59		
				C	25		
				E	49		
				d	M4		
N1-A2 N1A-A2 N1B-A2		<p>Comando manuale ruotato di 180° con attivazione del contatto elettrico del microswitch centralizzato.</p> <p>N1-A2: Per doppio effetto N1A-A2: Per semplice effetto in pos 1 N1B-A2: Per semplice effetto in pos 2</p> <p><i>180° rotated hand control with ON-OFF centralized microswitch operation.</i></p> <p><i>N1-A2: Double acting</i> <i>N1A-A2: Single acting in 1 position</i> <i>N1B-A2: Single acting in 2 position</i></p>	<p>Microswitch non di nostra fornitura <i>Microswitch not supplied by us</i></p> 	A	70	84	
				B	59		
				C	25		
				E	49		
				d	M4		
N1-A3 N1A-A3 N1B-A3		<p>Comando microswitch centralizzato.</p> <p>N1-A3: Per doppio effetto N1A-A3: Per semplice effetto in pos 1 N1B-A3: Per semplice effetto in pos 2</p> <p><i>Centralized microswitch control.</i></p> <p><i>N1-A3: Double acting</i> <i>N1A-A3: Single acting in 1 position</i> <i>N1B-A3: Single acting in 2 position</i></p>	<p>Microswitch non di nostra fornitura <i>Microswitch not supplied by us</i></p> 	A	70	84	
				B	59		
				E	49		
				C	25		
				d	M4		

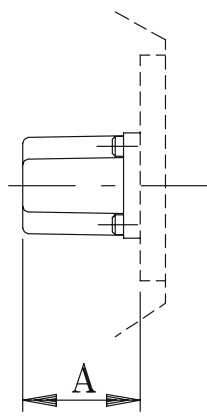
ASTE DI COMANDO / CONTROL LEVERS			Q25 Q45	Q30 Q50	Q75 Q95	Q80 Q130
CODICE CODE	DESCRIZIONE DESCRIPTION		M	M8	M10	
M8: 06.029.22862 M8: 06.029.30335(*) M10: 06.029.27013	Versione standard <i>Standard version</i>		M	M8	M10	
			L	164	210	
			øD	20		
			A	57		
			B	20	28	
M8: 06.029.30528 M8: 06.029.30492(*)	Versione lunga tipo "A" <i>Long version type "A"</i>		M	M8	/	
			L	184	/	
			øD	20	/	
			A	57	/	
			B	20	/	
M8: 06.029.28922 M8: 06.029.30336(*) M10: 06.029.28148	Versione lunga <i>Long version</i>		M	M8	M10	
			L	204	360	
			øD	25	22	
			A	57	61	
			B	20	28	
M8: 06.029.27421 M10: 06.029.27020	Versione extra lunga <i>Extra-long version</i>		M	M8	M10	
			L	328	507	
			øD	25	22	
			A	57	61	
			B	20	28	
M10: 06.000.27344	Versione corta <i>Short version</i>		M	/	M10	
			L	/	156	
			øD	/	22	
			A	/	61	
			B	/	28	
M8: 06.029.22876 M10: 06.029.27635	Versione extra corta <i>Extra-short version</i>		M	M8	M10	
			L	73	66	
			øD	18	22	
			A	50	61	
			B	20	22	
M8: 06.000.29451 M10: 06.000.29866	Versione con oblò <i>Handle with lens</i>		M	M8	M10	
			L	175	220	
			øD	32		
			A	45		
			B	20	28	
M8: 06.000.29423 M10: 06.000.30295	Versione lunga con oblò <i>Long version handle with lens</i>		M	M8	M10	
			L	215	367	
			øD	32		
			A	45		
			B	20	28	

(*): Versione con pomolo di colore Rosso
Version with red knob

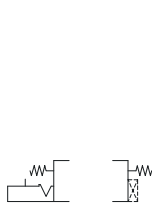
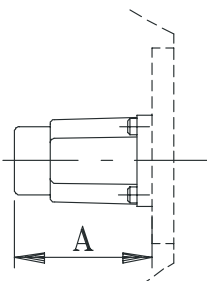
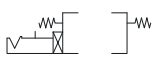
POSIZIONAMENTI / POSITIONINGS				Q25	Q30	Q75	Q80	Q130
CODICE CODE	SIMBOLO IDRAULICO HYDRAULIC SYMBOL	DESCRIZIONE DESCRIPTION		Q45	Q50	Q95		
M1		Tre posizioni ritorno a molla in pos.0. <i>Three spring positions centred in 0.</i>		A	42	55		
M2		Due posizioni 0-1 ritorno a molla in pos.0. <i>Two spring positions 0-1 centred in 0.</i>						
M3		Due posizioni 0-2 ritorno a molla in pos.0. <i>Two spring positions 0-2 centred in 0.</i>						
M4 2-1		Due posizioni estreme ritorno a molla in pos.2. <i>Two end positions spring back in 2.</i>						
R1		Tre posizioni ritorno a molla in pos.0, detent in pos.1. <i>Three spring positions centred in 0, detent in 1.</i>		A	52	70		
R2		Tre posizioni ritorno a molla in pos.0, detent in pos.2. <i>Three spring positions centred in 0, detent in 2.</i>						
R3		Tre posizioni in detent. <i>Three detent positions.</i>		A	42	55		
R4		Due posizioni in detent 0-1. <i>Two detent positions 0-1.</i>						
R5		Due posizioni in detent 0-2. <i>Two detent positions 0-2.</i>						
R6		Due posizioni in detent 1-2. <i>Two detent positions 1-2.</i>						
R8		Due posizioni (1 e 2) con ritorno a molla in pos. 0; Pos. 3: 4° posizione flottante con detent. (Da montare con Z1 lato comando). <i>Two positions (1 and 2) with spring return centred in 0 position. Position 3, 4th position, floating with detent. (Mounting with Z1 side control).</i>		A	56.5	75	80	
R10/Z1		Due posizioni (1 e 2) con ritorno a molla in pos. 0, Pos. 3: 4^ posizione flottante con detent. <i>Two positions (1 and 2) with spring return centred in 0, position 3: 4th position floating with detent.</i>						

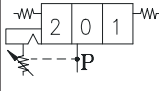
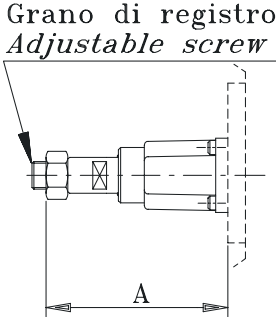
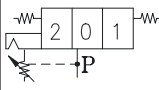
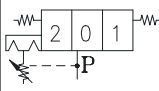
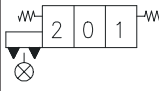
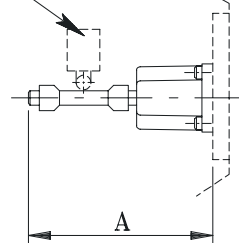
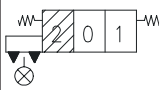
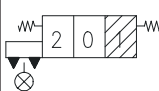
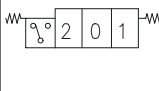
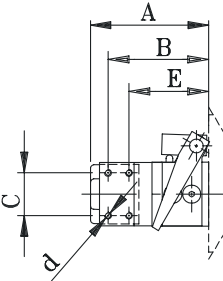
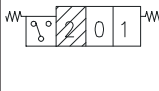
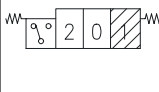
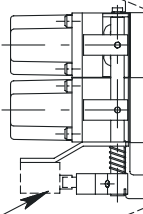
POSIZIONAMENTI / POSITIONINGS			Q25	Q30	Q75	Q80
CODICE CODE	SIMBOLO IDRAULICO HYDRAULIC SYMBOL	DESCRIZIONE DESCRIPTION	Q45	Q50	Q95	Q130
R1K		Comando a 3 posizioni, detent in pos.1 con sgancio automatico registrabile. Disponibile solo con cursore cod.103 e 111. <i>3 Position control, detent in 1 pos. with automatic adjustable release. Available with spool code 103 and 111 only.</i>	 <p>Grano di registro <i>Adjustable screw</i></p>			
R2K		Comando a 3 posizioni, detent in pos.2 con sgancio automatico registrabile. Disponibile solo con cursore cod.103 e 111. <i>3 Position control, detent in 2 pos. with automatic adjustable release. Available with spool code 103 and 111 only.</i>				
R3K		Comando a 3 posizioni, detent in pos. 1 e 2 con sgancio automatico. Disponibile solo con cursore cod.103 e 111 <i>3 Position control, detent in 1 and 2 pos. with automatic adjustable release. Available with spool code 103 and 111 only.</i>				
M1-B1		Tre posizioni ritorno a molla in pos.0 con comando microswitch posteriore. <i>Three spring positions centred in 0 with back microswitch control.</i>	 <p>Microswitch non di nostra fornitura <i>Microswitch not supplied by us</i></p>			
M2-B1		Due posizioni, 0-1, ritorno a molla in pos.0 con comando microswitch posteriore. <i>Two position, 0-1, spring centred in 0 with back microswitch control.</i>				
M3-B1		Due posizioni, 0-2, ritorno a molla in pos.0 con comando microswitch posteriore. <i>Two position, 0-2, spring centred in 0 with back microswitch control.</i>				
M1-N1 M1-N1A M1-N1B		Tre posizioni ritorno a molla in pos.0, con attivazione del contatto elettrico del microswitch centralizzato. M1-N1: Per doppio effetto M1-N1A: Per semplice effetto in pos 1 M1-N1B: Per semplice effetto in pos 2 <i>Three spring positions centred in 0, with ON-OFF centralized microswitch operation.</i> <i>N1-A1: Double acting</i> <i>N1A-A1: Single acting in 1 position</i> <i>N1B-A1: Single acting in 2 position</i>				
M2-N1		Due posizioni, 0-1, con ritorno a molla in pos.0, con attivazione del contatto elettrico del microswitch centralizzato. <i>Two positions, 0-1, with spring centred in 0, with ON-OFF centralized microswitch operation.</i>				
M3-N1		Due posizioni, 0-2, con ritorno a molla in pos.0, con attivazione del contatto elettrico del microswitch centralizzato. <i>Two positions, 0-2, with spring centred in 0, with ON-OFF centralized microswitch operation.</i>				
			 <p>Microswitch non di nostra fornitura <i>Microswitch not supplied by us</i></p>			

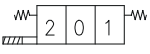
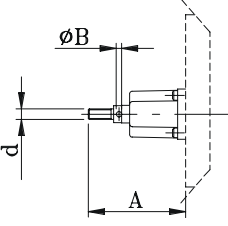
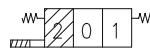
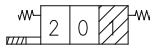
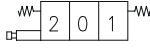
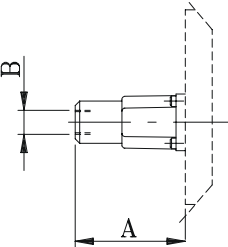
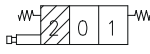
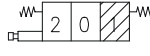
COMANDI CON POSIZIONAMENTO / CONTROLS WITH POSITIONING				Q25 Q45	Q30 Q50	Q75 Q95	Q80 Q130
CODICE CODE	SIMBOLO IDRAULICO HYDRAULIC SYMBOL	DESCRIZIONE DESCRIPTION					
M1-U1		<p>Tre posizioni con ritorno a molla in pos.0, attacco diretto sul cursore per rinvio a distanza rigido.</p> <p><i>Three spring positions centred in 0, with direct control connection on spool, cap side, for stiff remote control.</i></p>		A	73	96	
M2-U1		<p>Due posizioni, 0-1, con ritorno a molla in pos.0, attacco diretto sul cursore per rinvio a distanza rigido.</p> <p><i>Two positions, 0-1, spring centred in 0, with direct control connection on spool, cap side, for stiff remote control.</i></p>		B	4	5	
M3-U1		<p>Due posizioni, 0-2, con ritorno a molla in pos.0, attacco diretto sul cursore per rinvio a distanza rigido.</p> <p><i>Two positions, 0-2, spring centred in 0, with direct control connection on spool, cap side, for stiff remote control.</i></p>		d	M8	M10	
M1-U2		<p>Tre posizioni con ritorno a molla in pos.0, attacco diretto sul cursore per cavo flessibile rinvio a distanza.</p> <p><i>Three spring positions centred in 0, direct control connection on spool, cap side, for flexible remote control.</i></p>		A	73	77	
M2-U2		<p>Due posizioni, 0-1, ritorno a molla in pos.0, attacco diretto sul cursore per cavo flessibile rinvio a distanza.</p> <p><i>Two positions, 0-1, spring centred in 0, direct control connection on spool, cap side, for flexible remote control.</i></p>		B	M16x1.5		
M3-U2		<p>Due posizioni, 0-2, ritorno a molla in pos.0, attacco diretto sul cursore per cavo flessibile rinvio a distanza.</p> <p><i>Two positions, 0-2, spring centred in 0, direct control connection on spool, cap side, for flexible remote control.</i></p>		B	M16x1.5		

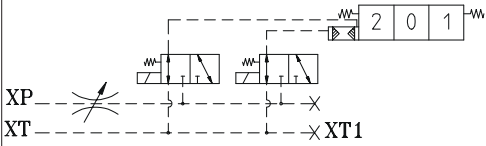
COMANDI CON POSIZIONAMENTO / CONTROLS WITH POSITIONING			Q25	Q30	Q95	Q80
CODICE CODE	SIMBOLO IDRAULICO HYDRAULIC SYMBOL	DESCRIZIONE DESCRIPTION	Q45	Q50	Q75	Q130
D2		Comando elettroidraulico doppio con ritorno in pos. 0 <i>Double electro-hydraulic control, spring centred in 0.</i>			*	*

Vite di regolazione velocità di commutazione
Commutation speed adjusting screw

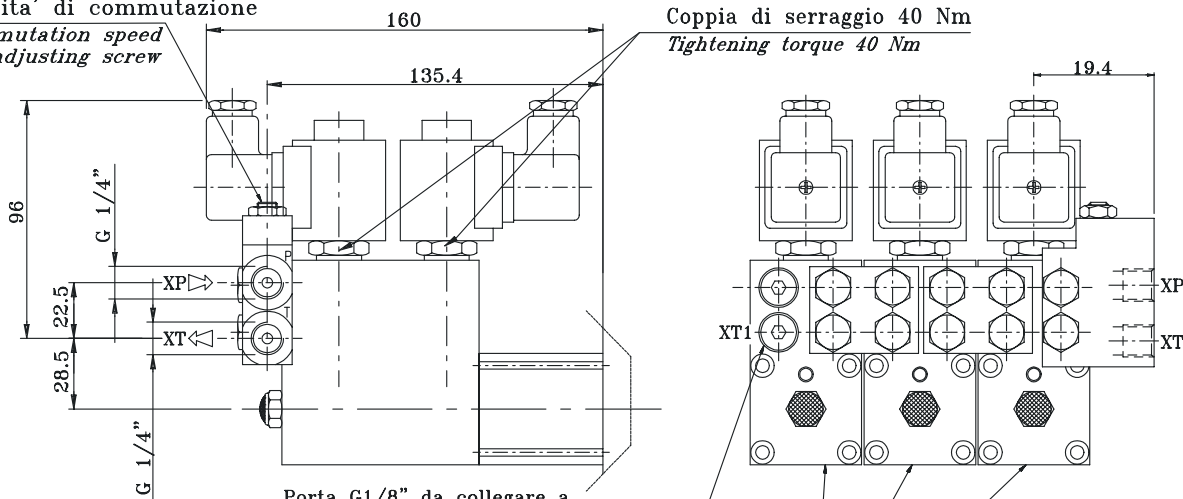

Porta G1/8" da collegare a serbatoio in caso di utilizzo di elemento intermedio cod. E62
If use the intermediate element E62 connect the port G1/8" to the tank

Codice: D2-2R per elementi successivi
Code: D2-2R for the following elements

Codice: D1-1R per il 1° elemento
Code: D2-1R for the 1° elements

Pressione di pilotaggio in XP <i>Pilot pressure in XP</i>		Contropressione max. su XT <i>Maximum back pressure on XT</i>	Portata minima per ogni elemento <i>Minimum flow for each section</i>	Volume di pilotaggio per elemento <i>Piloting volume for each section</i>
Max.	Min.	4 bar	0.5 lt/min	5.5cm ³
35 bar	20 bar			

CARATTERISTICHE TECNICHE ELETTROMAGNETE TIPO "H"
ELECTROMAGNET CHARACTERISTICS TYPE "H"

Attacco magnete <i>Magnet connection</i>	Tipo DIN 43650 (versione A) <i>Type DIN 43650 (A version)</i>
Tipo di protezione <i>Protection type</i>	IP 65
Classe d'isolamento <i>Coil insulation class</i>	H 180 VDE 0580
Tensione di alimentazione <i>Supply voltage</i>	D.C.: 12, 24V A.C. 50 Hz: 110, 220 V
Variatione di tensione max. <i>Maximum voltage tolerance</i>	± 10%
Potenza assorbita <i>Absorbed power supply</i>	18 W
Rapporto di max. utilizzo <i>Maximum utilization ratio</i>	100%
Temperatura max. <i>Max. temperature</i>	100°C

COMANDI CON POSIZIONAMENTO/ CONTROL WITH POSITIONING			Q25 Q45	Q30 Q50	Q75 Q95	Q80 Q130	
CODICE CODE	SIMBOLO IDRAULICO HYDRAULIC SYMBOL	DESCRIZIONE DESCRIPTION					
P1-N		Comando pneumatico a tre posizioni, ritorno in posizione 0 <i>Three pneumatic control positions, spring centred in 0</i>	A	90.5		107	
			B	43		48	
			C	10		10.5	
			d	G 1/8"			

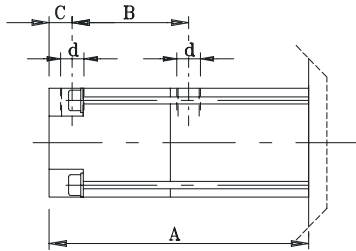

Pressione di pilotaggio / Piloting pressure	Min.	5 bar
	Max.	30 bar
Volume pilotaggio / Piloting volume	Q25-Q45-Q30-Q50	4 cm ³
	Q75-Q95-Q80-Q130	9 cm ³

COMANDI CON POSIZIONAMENTO/ CONTROL WITH POSITIONING			Q25 Q45	Q30 Q50	Q75 Q95	Q80 Q130	
CODICE CODE	SIMBOLO IDRAULICO HYDRAULIC SYMBOL	DESCRIZIONE DESCRIPTION					
P1-NP		Comando pneumatico progressivo a tre posizioni, ritorno in posizione 0 per azionamento con manipolatore <i>Three positions progressive pneumatic control, spring centred in 0 for remote control.</i>	C	90.5		107	
			E	43		48	
			F	10		10.5	
			d	G 1/8"			



DIAGRAMMA PRESSIONE DI PILOTAGGIO / CORSA SPOOL
PILOTING PRESSURE DIAGRAM / SPOOL STROKE



Pressione di pilotaggio / Piloting pressure	Min.	5 bar
	Max.	30 bar
Volume pilotaggio / Piloting volume	Q25-Q45-Q30-Q50	4 cm ³
	Q75-Q95-Q80-Q130	9 cm ³

COMANDI CON POSIZIONAMENTO / CONTROLS WITH POSITIONING			Q25 Q45	Q30 Q50	Q75 Q95	Q80 Q130
CODICE CODE	SIMBOLO IDRAULICO HYDRAULIC SYMBOL	DESCRIZIONE DESCRIPTION				
D3		Comando elettropneumatico a tre posizioni, ritorno in posizione 0. <i>Three electro-pneumatic control positions, spring centred in 0</i>	A	90.5	107	
			B	82.4	86.1	
			C	29.4	33.1	
			d	G 1/8"		
			E	11.7	12	

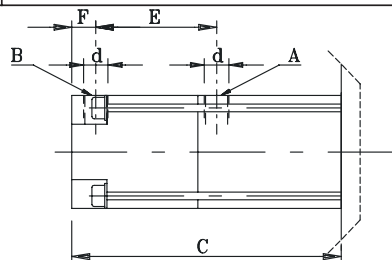
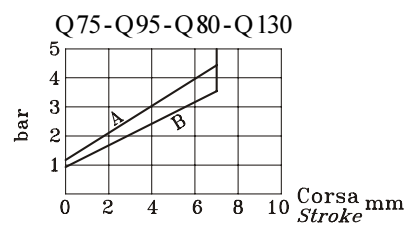
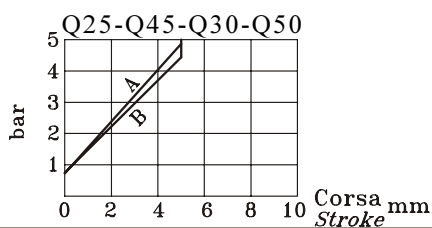
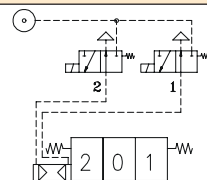
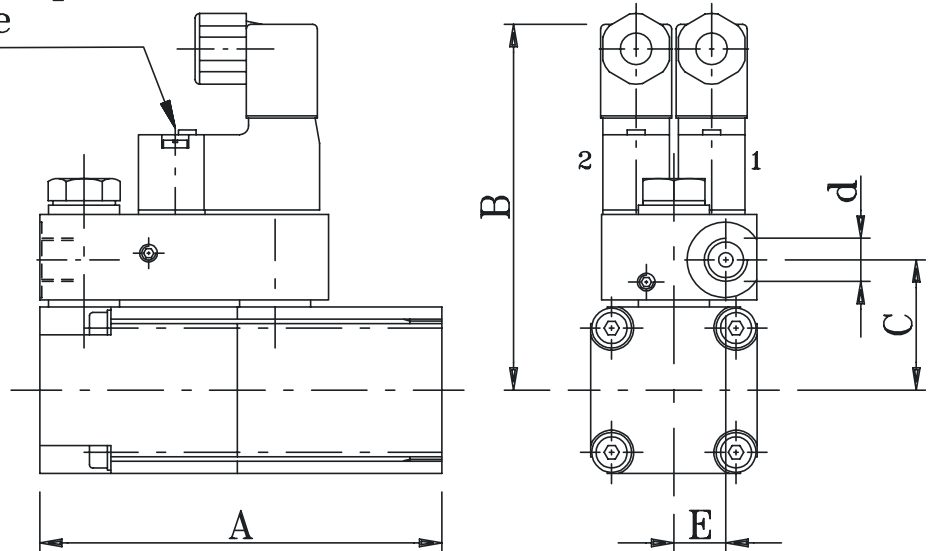
Emergenza manuale a spinta
Push manual override

Pressione di plottaggio / Piloting pressure	Min.	5 bar
	Max.	10 bar
Volume pilotaggio / Piloting volume	Q25 - Q45 - Q30 - Q50	4 cm ³
	Q75 - Q95 - Q80 - Q130	9 cm ³

CARATTERISTICHE TECNICHE ELETTROMAGNETE
ELECTROMAGNET CHARACTERISTICS

Attacco magnete <i>Magnet connection</i>	Tipo DIN 43650 (versione C) PG7 <i>Type DIN 43650 (C version) - PG7</i>
Tipo di protezione <i>Protection type</i>	IP 65
Classe d'isolamento <i>Coil insulation class</i>	F 155°C
Tensione di alimentazione <i>Supply voltage</i>	D.C.: 12, 24V A.C. 50 Hz: 24, 110, 230 V
Variazione di tensione max. <i>Maximum voltage tolerance</i>	-15% ÷ + 10%
Potenza assorbita <i>Absorbed power supply</i>	A.C. : 2.5 VA D.C. : 2.5 W
Rapporto di max. utilizzo <i>Maximum utilization ratio</i>	100%
Temperatura max. <i>Max. temperature</i>	-10° ÷ 50°C

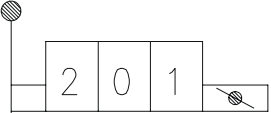
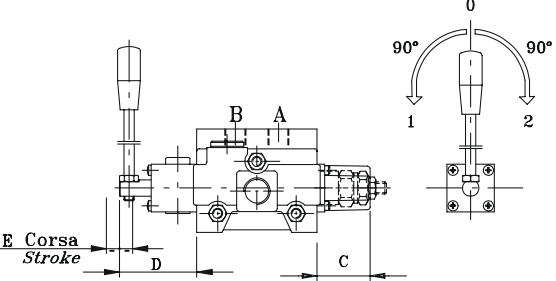
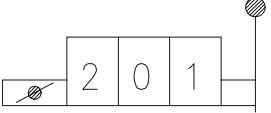
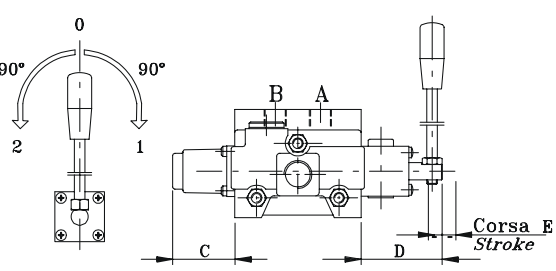
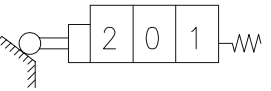
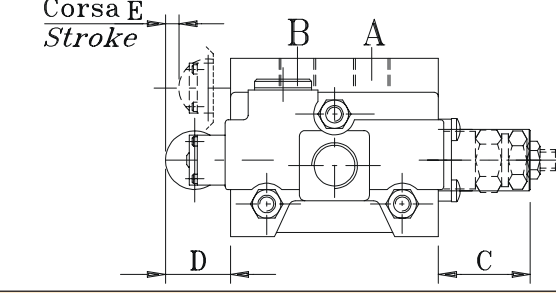
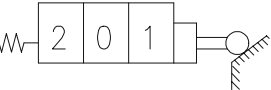
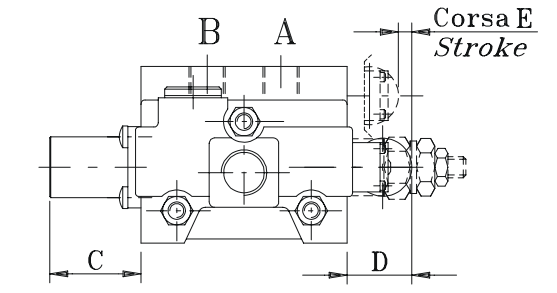
COMANDI CON POSIZIONAMENTO / CONTROLS WITH POSITIONING			Q25	Q30	Q95	Q80
CODICE CODE	SIMBOLO IDRAULICO HYDRAULIC SYMBOL	DESCRIZIONE DESCRIPTION	Q45	Q50	Q75	Q130
RTL-s		Tre posizioni con comando rotativo frizionato, tacca in pos. 0, leva in pos. 2. <i>Three positions with cluched rotary control, lever in 2 posito.</i>	C	42	55	
			D	61	72.5	
			E	10 (5 + 5)	14 (7 + 7)	
RTL-d		Tre posizioni con comando rotativo frizionato, tacca in pos. 0, leva in pos. 1. <i>Three positions with cluched rotary control 0, lever in 1 position</i>	C	15	20	
			D	61	72.5	
			E	10 (5 + 5)	14 (7 + 7)	
C2		Comando a camme 2 pos. estreme 1-2, con ritorno a molla in pos. 1. <i>Cam control, 2 end positions 1-2, spring centred in 1 position.</i>	C	42	55	
			D	43	51	
			E	10	14	
C3		Comando a camme, 2 pos. estreme 2-1, con ritorno a molla in pos. 2. <i>Cam control, 2 end positions 2-1, spring centred in 2 position.</i>	C	42	55	
			D	43	51	
			E	10	14	

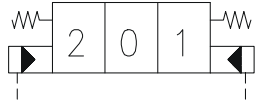
COMANDI COMPLETI / COMPLETE CONTROLS			Q25	Q30	Q75	Q80
CODICE CODE	SIMBOLO IDRAULICO HYDRAULIC SYMBOL	DESCRIZIONE DESCRIPTION	Q45	Q50	Q95	Q130
H1		Comando idraulico ad alta pressione ON-OFF a tre posizioni, ritorno a molla in posizione 0. <i>Three positions whit high-pressure hydraulic control, spring centred in 0 position.</i>	A	70	85	
			d	G 1/4"		

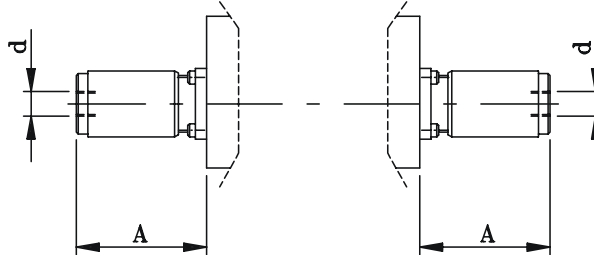

Pressione di plottaggio / Piloting pressure	Min.	16 bar
	Max.	350 bar
Volume pilotaggio / Piloting volume	Q25 - Q45 - Q30 - Q50	2 cm ³
	Q75 - Q95 - Q80 - Q130	3 cm ³

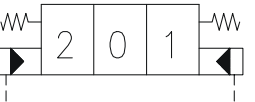
COMANDI COMPLETI / COMPLETE CONTROLS			Q25	Q30	Q75	Q80
CODICE CODE	SIMBOLO IDRAULICO HYDRAULIC SYMBOL	DESCRIZIONE DESCRIPTION	Q45	Q50	Q95	Q130
H5		Comando idraulico a bassa pressione a tre posizioni per manipolatore idraulico, ritorno a molla in posizione 0. <i>Three positions whit low-pressure control for hydraulic remote control, spring centred in 0 position.</i>	A	50	71.5	
			d	G 1/4"		



DIAGRAMMA PRESSIONE DI PILOTAGGIO / CORSA SPOOL
PILOTING PRESSURE DIAGRAM / SPOOL STROKE



Pressione di plottaggio / Piloting pressure	Max.	100 bar
Volume pilotaggio / Piloting volume	Q25 - Q45 - Q30 - Q50	2 cm ³
	Q75 - Q95 - Q80 - Q130	3 cm ³

ELEMENTI INTERMEDI / INTERMEDIATE SECTIONS			Q30	Q80	Q130
CODICE <i>CODE</i>	SIMBOLO IDRAULICO <i>HYDRAULIC SYMBOL</i>	DESCRIZIONE <i>DESCRIPTION</i>	Q50		
E50		Elemento intermedio con VLP. (* per la tarature vedi nota * nella pag. "Collettori di scarico") <i>Intermediate section with relief valve</i> <i>(For the setting see note * in the page of "Outlet sections")</i>	*	*	*
E51		Collettore di uscita intermedio. <i>Intermediate outlet section.</i>	*	*	*
E53		Elemento intermedio per entrata 2[^] pompa con VLP. (* per la tarature vedi nota * nella pag. "Collettori di scarico") <i>Intermediate inlet section for 2nd pump with relief valve. (For the setting see note * in the page of "Outlet sections")</i>	*	*	*
E58		Elemento intermedio con divisore di portata 3 vie compensato registrabile con cacciavite (tipo "C") o con volantino (tipo "V"). <i>Intermediate section with 3 way flow divider adjustable and compensated whit screwdriver (type "C") or handweel (type "V").</i>	*	*	
E68		Elemento intermedio con divisore di portata 3 vie compensato registrabile con cacciavite (tipo "C") o con volantino (tipo "V"). <i>Intermediate section with 3 way flow divider adjustable and compensated whit screwdriver (type "C") or handweel (type "V").</i>	*	*	
E62		Elemento intermedio con valvola riduttrice di pressione per pilotaggio comando elettroidraulico. <i>Intermediate section with pressure reducing valve for piloting electro-hydraulic control.</i>		*	*
E61		Elemento intermedio di spessoramento <i>Intermediate spacer element</i>	*	*	
		Spessore elementi intermedi mm <i>Thickness of the intermediate element</i>	38	46	48

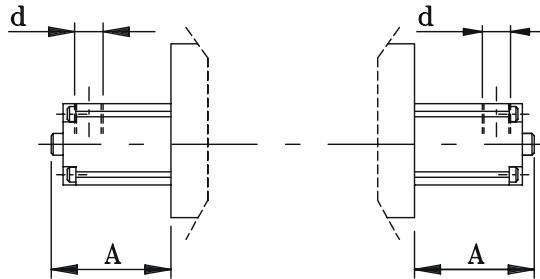
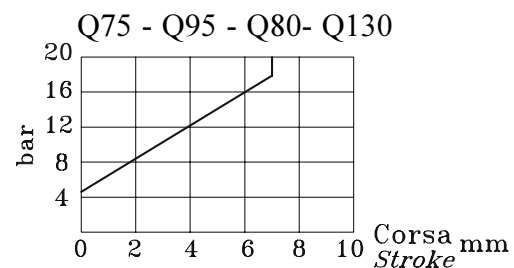
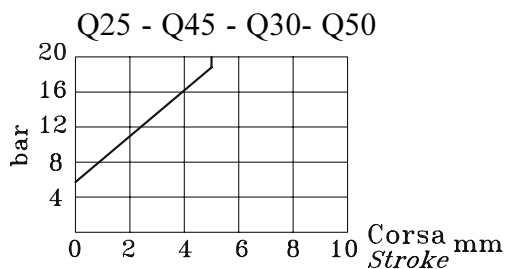
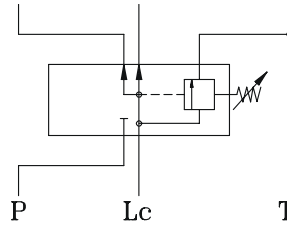
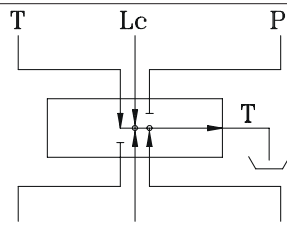
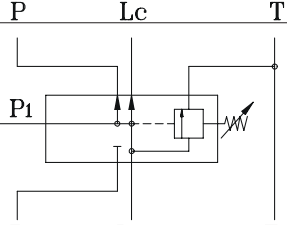
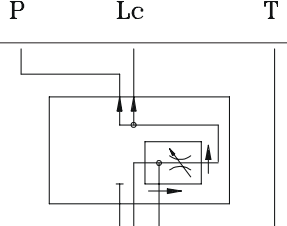
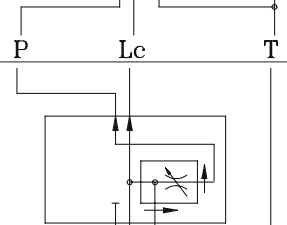
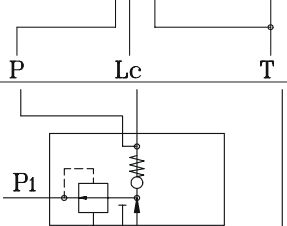
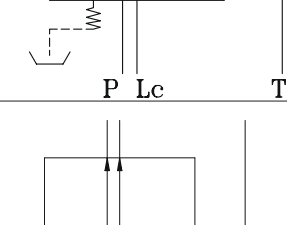
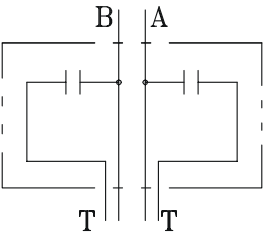
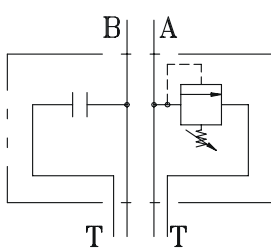
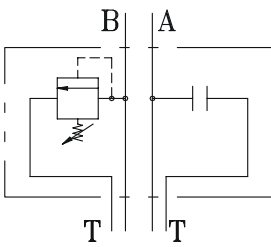
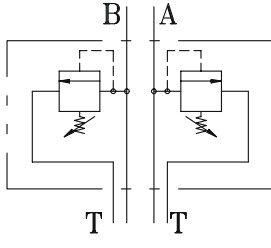
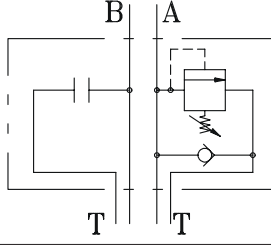
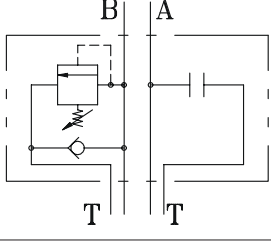
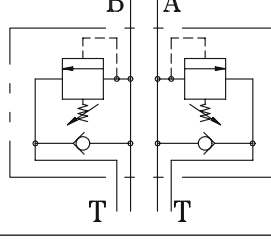
VALVOLE A CARTUCCIA INCORPORATE NELL' ELEMENTO BUILT-IN CARTRIDGE VALVES			Q30 Q50	Q80	Q130
CODICE CODE	SIMBOLO IDRAULICO HYDRAULIC SYMBOL	DESCRIZIONE DESCRIPTION			
VC		Tappe di chiusura per corpo distributore predisposto per valvole antiurto e/o anticavitazione. <i>Closing plug for directional control valve body preset for shock and/or anticavitation valves.</i>	*	*	*
V30		Valvola limitatrice di pressione (o antiurto), registrabile, su effetto A (per le tarature vedere pag.seguente *). <i>Pressure limiting valve (or antishock), adjustable, on A port (for the setting see next page*).</i>	*	*	*
V31		Valvola limitatrice di pressione (o antiurto), registrabile, su effetto B (per le tarature vedere pag.seguente*). <i>Pressure limiting valve (or antishock), adjustable, on B port (for the setting see next page*).</i>	*	*	*
V32		Valvola limitatrice di pressione (o antiurto), registrabile su effetto A e B (per le tarature vedere pag. seguente*). <i>Pressure limiting valve (or antishock), adjustable, on A and B port (for the setting see next page*).</i>	*	*	*
V33		Valvola limitatrice di pressione (o antiurto), registrabile, con anticavitazione, su effetto A (per le tarature vedere pag. seguente*). <i>Pressure limiting valve (or antishock), adjustable, with anticavitation, on A port (for the setting see next page*).</i>	*	*	*
V34		Valvola limitatrice di pressione (o antiurto), registrabile, con anticavitazione, su effetto B (per le tarature vedere pag. seguente*). <i>Pressure limiting valve (or antishock), adjustable, with anticavitation, on B port (for the setting see next page*).</i>	*	*	*
V35		Valvola limitatrice di pressione (o antiurto), registrabile, con anticavitazione, su effetti A e B (per le tarature vedere pag. seguente*). <i>Pressure limiting valve (or antishock), adjustable, with anticavitation, on A and B ports (for the setting see next page*).</i>	*	*	*

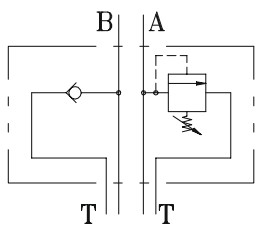
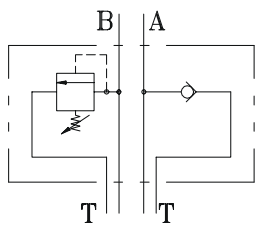
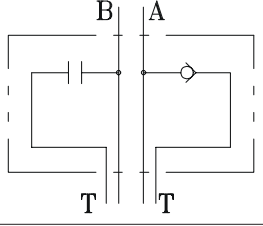
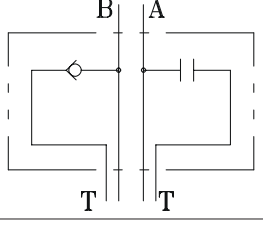
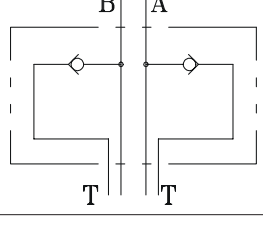
VALVOLE A CARTUCCIA INCORPORATE NELL' ELEMENTO BUILT-IN CARTRIDGE VALVES			Q30 Q50	Q80	Q130
CODICE CODE	SIMBOLO IDRAULICO HYDRAULIC SYMBOL	DESCRIZIONE DESCRIPTION			
V40		Valvola limitatrice di pressione (o antiurto), registrabile su effetto A e anticavitazione su effetto B (per le tarature vedere *) <i>Pressure limiting valve (or antishock), adjustable on A port and anticavitation on B port (for the setting see *).</i>	*	*	*
V41		Valvola anticavitazione su effetto A e valvola limitatrice di pressione (o antiurto), registrabile su effetto B (per le tarature vedere *). <i>Anticavitation valve on A port and pressure limiting valve (or antishock), adjustable on B port (for the setting see *).</i>	*	*	*
V04		Valvola anticavitazione su effetto A. <i>Anticavitation valve on A port.</i>	*	*	*
V05		Valvola anticavitazione su effetto B. <i>Anticavitation valve on B port.</i>	*	*	*
V06		Valvola anticavitazione doppia su effetti A e B. <i>Anticavitation valve, double-acting on A and B ports.</i>	*	*	*

(*) Taratura o campo di taratura delle valvole ausiliarie da specificare in bar nell'ordine
Calibration fields of the auxiliary valves to specify during the purchase order (bar):

Q30 - Q50		Q80		Q130	
Tipo molla Spring type	Campi di taratura(**) Calibration fields	Tipo molla Spring type	Campi di taratura(**) Calibration fields	Tipo molla Spring type	Campi di taratura Calibration fields
"B"= molla bianca white spring	30 ÷ 80 bar	"B"= molla bianca white spring	30 ÷ 80 bar	"B"= molla bianca white spring	30 ÷ 80 bar
"N"= molla nera black spring	81 ÷ 200 bar	"N"= molla nera black spring	81 ÷ 200 bar	"N"= molla nera black spring	81 ÷ 200 bar
"G"= molla gialla yellow spring	201 ÷ 300 bar	"R"= molla rossa red spring	201 ÷ 370 bar	"R"= molla rossa red spring	201 ÷ 350 bar
"R"= molla rossa red spring	301 ÷ 400 bar				

(**) Il range completo si ottiene mediante l'aggiunta di spessori.
The complete fields can be obtain with additional thickness.

N.B.: in caso di omissione del valore di taratura, esso sarà inteso standard (molla nera) a 120 bar.
without the calibration valve it will be considered as a standard valve (black spring) at 120 bar.

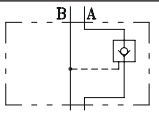
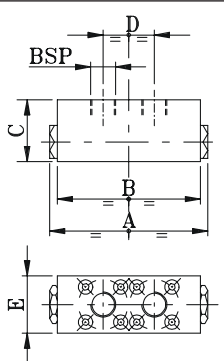
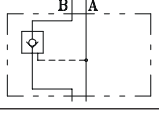
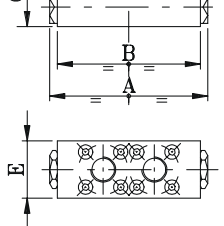
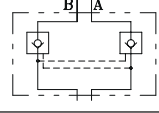
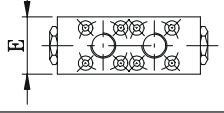
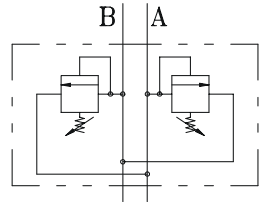
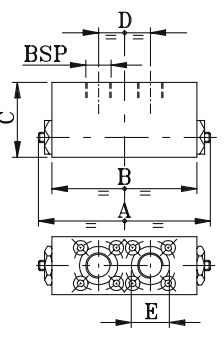
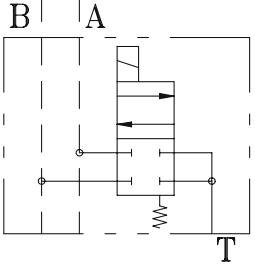
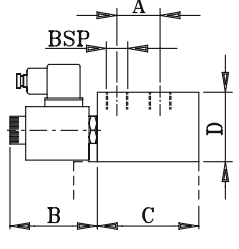
VALVOLE A PANNELLO / PANEL VALVES				Q30	Q80	Q130	
CODICE CODE	SIMBOLO IDRAULICO HYDRAULIC SYMBOL	DESCRIZIONE DESCRIPTION					
V01		Valvola di ritegno pilotata singola su effetto A (*). <i>Single piloted check valve on A port (*).</i>		A	105	130	173
				B	95	122	165
V02		Valvola di ritegno pilotata singola su effetto B (*). <i>Single piloted check valve on B port (*).</i>		C	41	50	65
				D	34	43	64
V03		Valvola di ritegno pilotata doppia su effetti A e B (*). <i>Double piloted check valve on A and B. (*).</i>		E	37.5	45	47
				BSP	3/8"	1/2"	3/4"
V36		Valvola limitatrice di pressione (o antiurto) con scarico incrociato registrabile. <i>Pressure limiting valve (or antishock) with adjustable and crossed outlet.</i>		A	102	/	/
				B	95	/	/
				C	41	/	/
				D	34	/	/
				E	25	/	/
				BSP	3/8"	/	/
VP		Corpo distributore predisposto per valvola a pannello. <i>Control valve body preset for panel-mounted valve.</i>		*	*	*	
VPC		Corpo distributore predisposto per valvola antiurto o anticavitazione e per valvola a pannello. <i>Control valve body preset for antishock valve or anticavitation and for panel-mounted valve.</i>		*	*	*	
VPFE		Corpo distributore predisposto per valvola di flottante elettrico a pannello. <i>Control valve body preset for electric floating valve, panel mounted.</i>		*			
VFE		Valvola per flottante elettrico. Da utilizzare su cursori con utilizzi A e/o B chiusi in pos. 0 per creare elettricamente la posizione di flottante. Specificare la tensione: 12 .DC.- 24V.DC. <i>Valve for electric floating.</i> <i>To use on spools with A and/or B ports closed in 0 position and for generathig electically the floating position</i> <i>Specify the voltage 12 V.DC. - 24 V.D.C.</i>		A	34	/	/
				B	69	/	/
				C	80	/	/
				D	80	/	/
				BSP	3/8"	/	/

(*) RAPPORTO DI PILOTAGGIO / (*) PILOTING RATIO

Q30	Q80	Q130
1 : 2.42	1 : 3.25	1 : 2.80

COPPIA DI SERRAGGIO DELLE VITI DI FISSAGGIO / FASTENING SCREW TIGHTENING

Q30	Q80	Q130
8 Nm	10 Nm	10 Nm

*2 Nm

*Solo per viti VFE / *Only for VFE screws

COMBINAZIONI POSSIBILI CON CAVO FLESSIBILE

POSSIBLE COMBINATIONS WITH FLEXIBLE REMOTE CONTROL

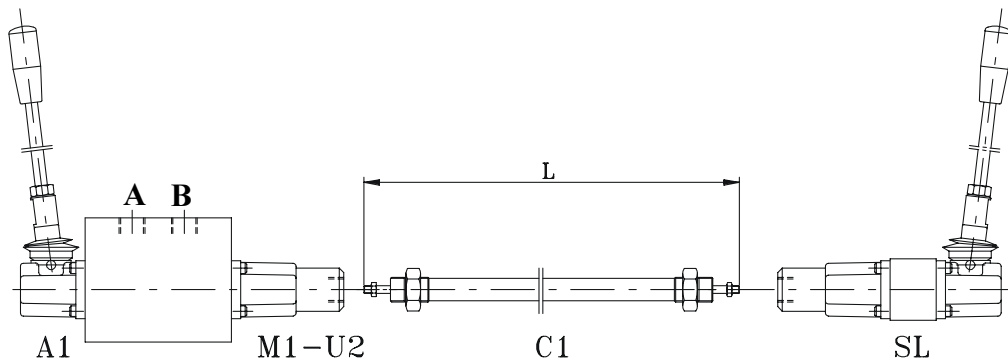

Codice: (tipo cursore)
Code: (spool type) / A1 / M1 - U2 - C1xL - SL

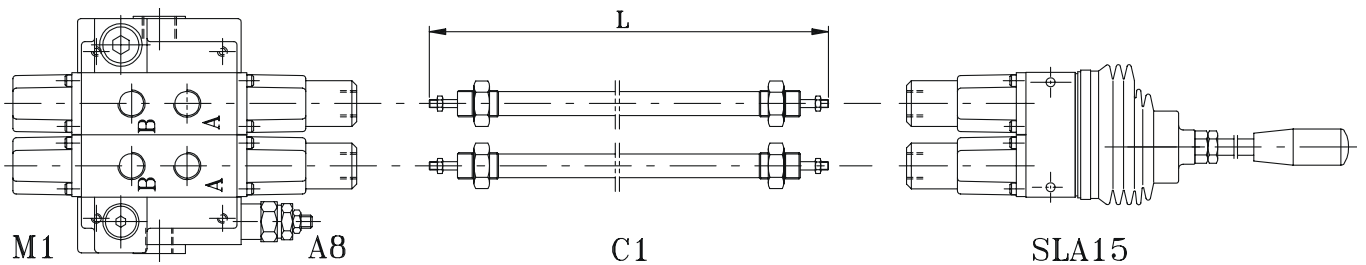

Codice: (tipo cursore) / A8 - C1xL - SLA 15 / M1 - (tipo cursore) / A8 - C1xL - M1
Code: (spool type)

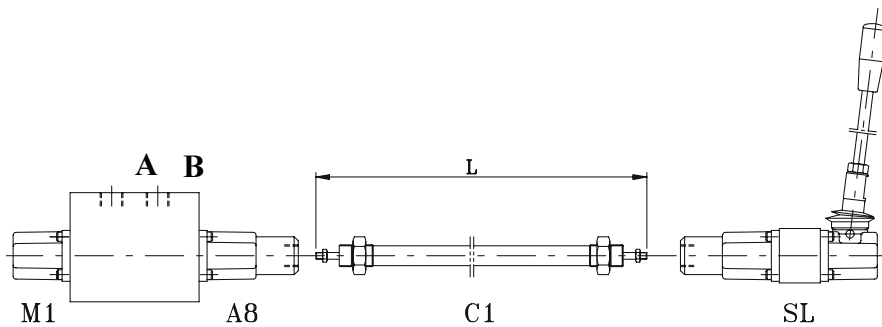

Codice: (tipo cursore)
Code: (spool type) / M1 / A8 - C1xL - SL

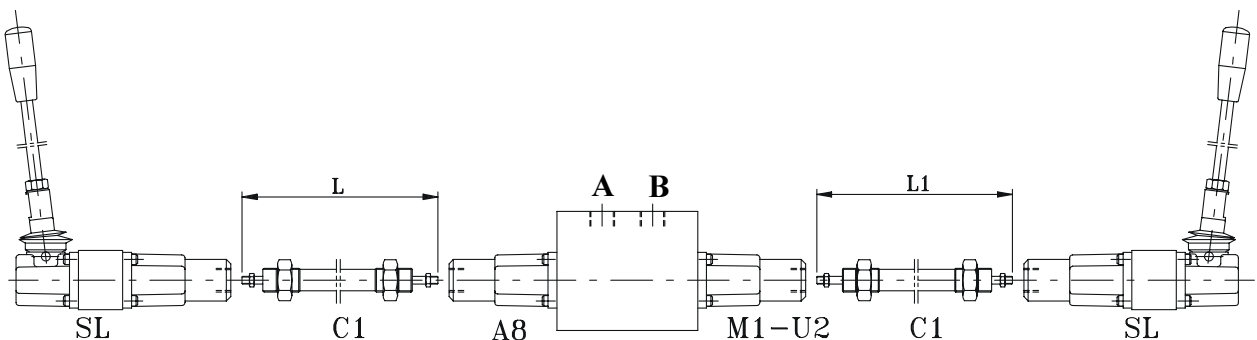

Codice: (tipo cursore)
Code: (spool type) / A8 - C1xL - SL / M1 - U2 - C1xL1 - SL

ESEMPIO DI ORDINAZIONE IN CODICE / EXAMPLE OF ORDERING CODE

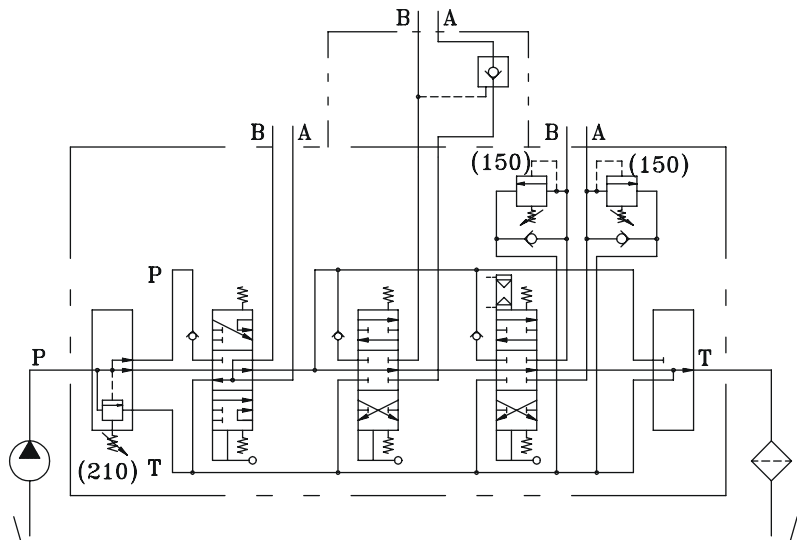
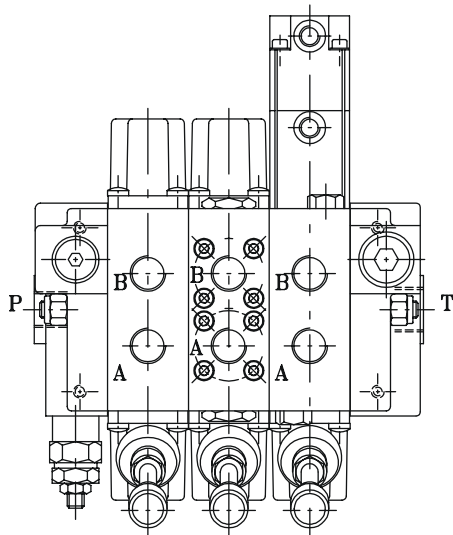

Q30- F7SR (210) - 411 / A1 / M1 - 103 / A1 / M1 / V01 - 103 / A1 / P1 / V35 (150) -F3D

Q30	Tipo distributore <i>Type of directional control valve</i>
F7SR (210)	Tipo di collettore di entrata <i>Inlet section type</i>
R	Tipo di molla per la VLP (rossa, nera o bianca) <i>Spring type for VLP (black, red or white)</i>
(210)	Taratura della VLP <i>VLP setting</i>
411 / A1 / M1	Cursore della prima sezione di lavoro <i>Spool type of first working section</i>
411	Comando lato bocca A <i>Control on A port side</i>
A1	Posizionamento lato bocca B <i>Positioning on B port side</i>
M1	
103 / A1 / M1 / V01	Cursore della seconda sezione di lavoro <i>Spool type of second working section</i>
103	Comando lato bocca A <i>Control on A port side</i>
A1	Posizionamento lato bocca B <i>Positioning on B port side</i>
M1	Valvola di ritegno pilotata singola su effetto A <i>Single piloted check valve on A port</i>
V01	
103 / A1 / P1 / V35 (150)	Cursore della terza sezione di lavoro <i>Spool type of third working section</i>
103	Comando lato bocca A <i>Control on A port side</i>
A1	Comando con posizionamento lato bocca B <i>Control with positioning on B port side</i>
P1	Valvola limitatrice di pressione registrabile e anticavitazione doppia su effetti A e B <i>Pressure limiting valve, adjustable and anticavitation, double-acting on A and B ports</i>
V35	Taratura valvola <i>Valve setting</i>
(150)	
F3D	Collettore di scarico <i>Outlet section</i>

N.B. per i distributori Q25 - Q45 e Q50 i
- COMANDI codice A1, A2, A3, A4, A5, A6, A8, SL, N1-A1, N1-A2, N1-A3 ed i
- POSIZIONAMENTI codice M1, M2, M3, R1, R2, R3, R4, R5, R6, R8, R10, M1-B1, M2-B1, M3-B1, M1-N1, M2-N1, M3-N1, M1-U1, M2-U1, M3-U1, M1-U2, M2-U2, M3-U2
sono disponibili a richiesta nella versione con scatola e cappellotto in alluminio indicando la dicitura "-S" al termine dell' ordinazione in codice.

N.B. for the directional control valvestype Q25 - Q45 and Q50 the
- CONTROLS code A1, A2, A3, A4, A5, A6, A8, SL, N1-A1, N1-A2, N1-A3 and the
- POSITIONING code M1, M2, M3, R1, R2, R3, R4, R5, R6, R8, R10, M1-B1, M2-B1, M3-B1, M1-N1, M2-N1, M3-N1, M1-U1, M2-U1, M3-U1, M1-U2, M2-U2, M3-U2
are available with aluminium box and cap. Mark "-S" at the end of the code show.

ESEMPIO DI ORDINAZIONE IN CODICE / EXAMPLE OF ORDERING CODE

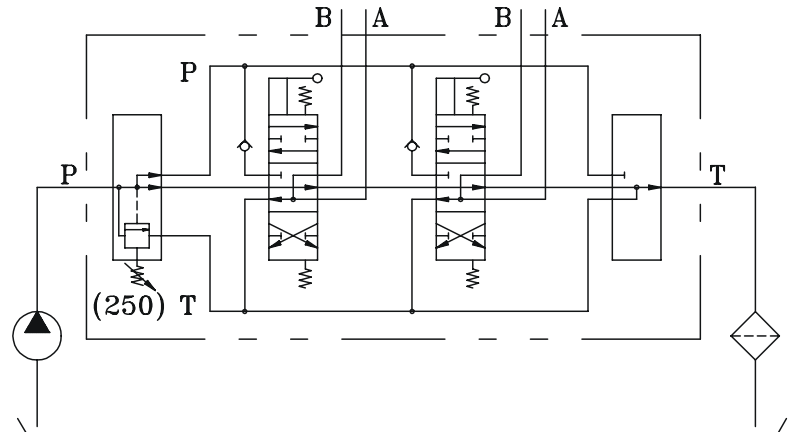
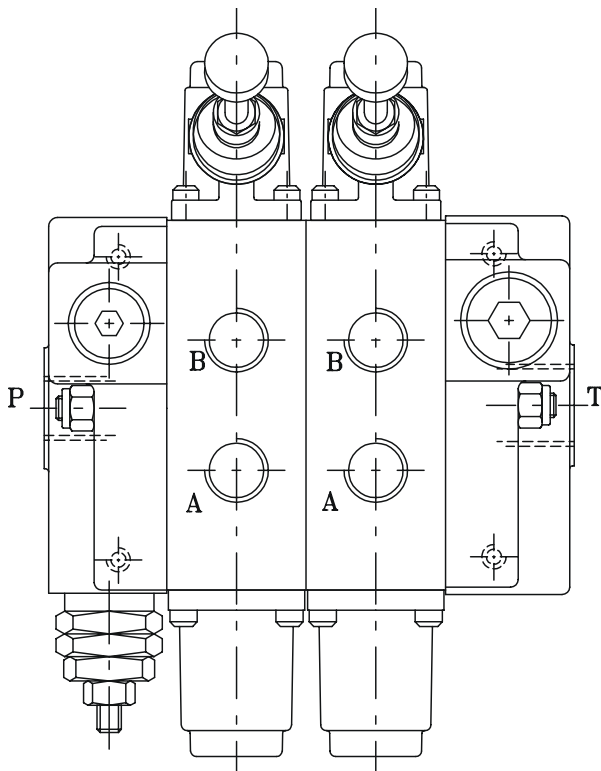

Q80 / F7SR (250) - 2x 111 / M1 / A1 - F3D

Q80	Tipo distributore <i>Type of directional control valve</i>
F7S	F7SR (250) Tipo di collettore di entrata <i>Inlet section type</i>
R	Tipo di molla per la VLP (rossa, nera o bianca) <i>Spring type for VLP (black, red or white)</i>
(250)	Taratura della VLP <i>VLP setting</i>
2x	2x 111 / M1 / A1 Due sezioni di lavoro consecutive uguali <i>Two consecutive and equal working sections</i>
111	Tipo di cursore <i>Spool type</i>
M1	Posizionamento lato bocca A <i>Positioning on A port side</i>
A1	Comando lato bocca B <i>Control on B port side</i>
F3D	Collettore di scarico <i>Outlet section</i>

ESEMPIO DI ORDINAZIONE IN CODICE / EXAMPLE OF ORDERING CODE

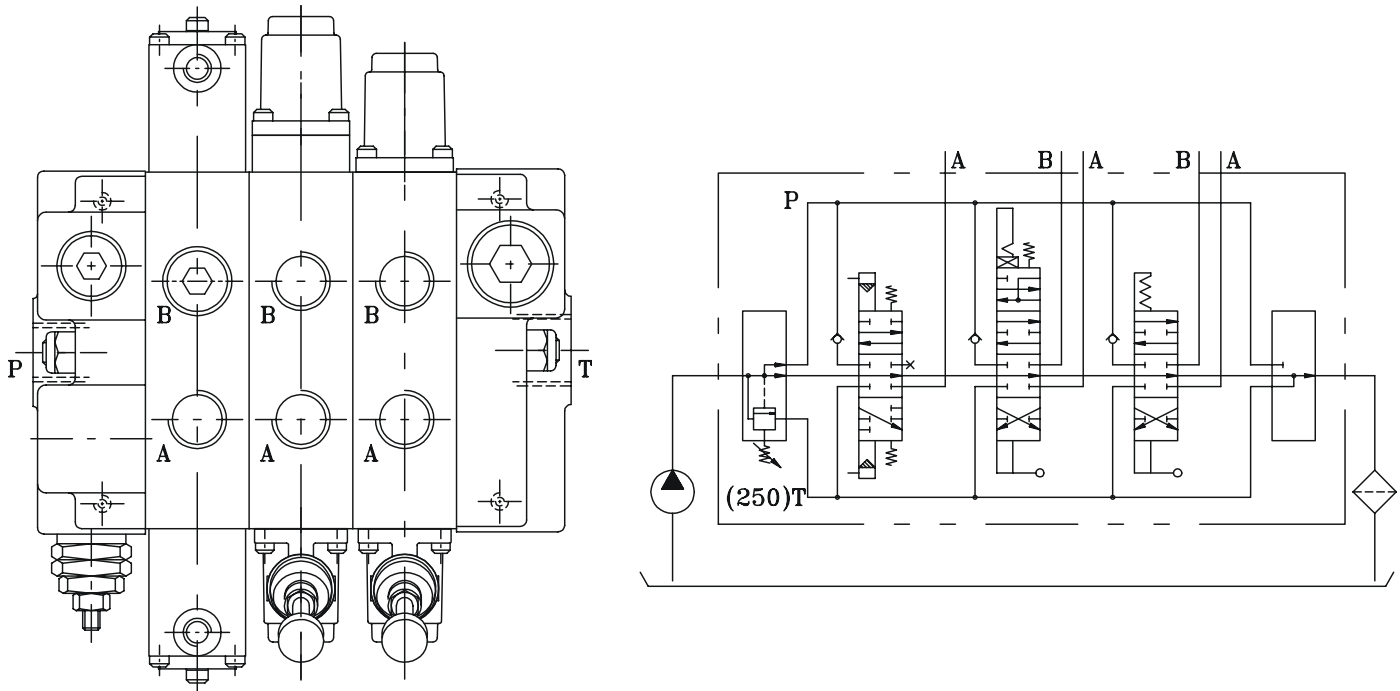

Q130 - F7SR (250) - 101 / H5 - 126 / A1 / R10 / Z1 - 103 / A1 / R3 - F3D

Q130

Tipo distributore
Type of directional control valve

F7SR (250)

F7S

Tipo di collettore di entrata
Inlet section type

R

Tipo di molla per la VLP (rossa, nera o bianca)
Spring type for VLP (black, red or white)

(250)

Taratura della VLP
VLP setting

101 / H5

101

Cursore della prima sezione di lavoro
Spool type of first working section

H5

Comando completo lato bocca A e B
Complete control on A and B port side

126 / A1 / R10 / Z1

126

Cursore della seconda sezione di lavoro
Spool type of second working section

A1

Comando lato bocca A
Control on A port side

R10 / Z1

Posizionamento a tacche lato bocca B con variante (Z1) per 4ª posizione invertita
Gate positioning on B port side with change (Z1) for reversed 4th position

103 / A1 / R3

103

Cursore della terza sezione di lavoro
Spool type of third working section

A1

Comando lato bocca A
Control on A port side

R3

Posizionamento lato bocca B
Positioning on B port side

F3D

Collettore di scarico
Outlet section

Galtech s.p.a. Via Kennedy, 10 - 42100 Reggio Emilia - Italy

Tel: +39.0522.300348 Fax: +39.0522.300803

<http://www.galtech.it> - e-mail: galtech@galtech.it